



ASA DENTAL®

PROGETTAZIONE E PRODUZIONE STRUMENTI DENTALI
DESIGN AND MANUFACTURING OF DENTAL INSTRUMENTS

Chirurgia

Surgical

**Chirurgia
Implantare**

Implant Surgery



*Dove nasce un sorriso...
Where smile rises...*



*Dove nasce un sorriso...
Where smile rises...*

ASA DENTAL®

Set di Strumenti per la Chirurgia Orale

Instruments Kit for Oral Surgery



S3002-18

Contenuto/Contents:

MV1807-08	Curette Gracey / Gracey Curette	MV1850-M9	Scollaperiosteo Molt / Molt Periosteal elevator
MV1807-12	Curette Gracey / Gracey Curette	MV1851-PR3	Scollaperiosteo Prichard / Prichard Periosteal elevator
MV1807-14	Curette Gracey / Gracey Curette	0350-5	Manico per bisturi retto / Straight scalpel handle
0304-1	Forbicina Goldman-Fox retta / Straight Goldman-Fox scissors	0350-5A	Manico per bisturi curvo / Curved scalpel handle
0304-2	Forbicina Goldman-Fox curva / Curved Goldman-Fox scissors	1800-1	Scalpello Ochsenbein / Ochsenbein Chisel
MV2001-85	Cucchiaino alveolare Lucas / Lucas Bone Curette	1800-2	Scalpello Ochsenbein / Ochsenbein Chisel
MV2001-86	Cucchiaino alveolare Lucas / Lucas Bone Curette	0445-14 TC	Porta aghi Castroviejo / Castroviejo Needle holder
MV1803-D	Bisturi Kirkland / Kirkland Knives	0435-14 TC	Porta aghi Mathieu / Mathieu Needle holder
MV1804-D	Bisturi Orban / Orban Knives	S2722-2	Vassoio / Tray



S3002-17

Contenuto/Contents:

2102-IN	Manico per specchietti / Mouth mirror handle	2602-1	Divaricatore Sternberg / Sternberg retractor
0700-23	Sonda / Explorer	2613-2	Divaricatore Senn-Miller / Senn-Miller retractor
0601-2	Pinzetta per medicazione London College / London College cotton and dressing pliers	0415-15TC	Porta aghi Crile-Wood / Crile-Wood needle holder
0631-1	Pinzetta chirurgica Semken-Taylor / Semken-Taylor tissue pliers	0430-14	Porta aghi Mathieu / Mathieu needle holder
1815-7	Bisturi Goldman-Fox / Goldman-Fox knives	0304-2	Forbicina Goldman-Fox / Goldman-Fox scissors
1804 D	Bisturi Orban / Orban knives	0500-1	Pinza emostatica Halstead-Mosquito retta / Straight Halstead-Mosquito haemostatic forceps
MV1850-M9	Scollaperiosteo Molt / Molt periosteal elevator	0500-2	Pinza emostatica Halstead-Mosquito curva / Curved Halstead-Mosquito haemostatic forceps
MV1851-PR3	Scollaperiosteo Prichard / Prichard periosteal elevator	2200-5	Specchietto / Mouth mirror
2616-1	Divaricatore Farabeuf / Farabeuf retractor	S2722-1	Vassoio / Tray



S3002-13

Contenuto/Contents:

0602-2	Pinzetta per medicazione / Cotton and dressing pliers	0320-2	Forbice per chirurgia Spencer retta / Straight Spencer surgical scissors
0635-3	Pinzetta per chirurgia / Tissue pliers	0321-2	Forbice per chirurgia Metzenbaum curva / Curved Metzenbaum surgical scissors
0625-1	Pinzetta per sutura / Suture pliers	2102-IN	Manico per specchietto / Mouth mirror handle
2611-2	Divaricatore / Retractor	2607	Divaricatore Buchwald / Buchwald retractor
0430-14	Porta aghi Mathieu / Mathieu needle holder	2200-4	Specchietto / Mouth mirror
0441-14	Porta aghi Castroviejo / Castroviejo needle holder	S2722-1	Vassoio / Tray
0350-3	Manico per bisturi / Scalpel handle		

Forbicine per Gengive

Gum Scissors



0300-1
Fig. 1
cm. 12

Rette
Straight



Curve
Curved
0300-2
Fig. 2



0301-1
Fig. 1
cm. 11,5

Angolari
Angular



0301-2
Fig. 2

Angolari, una
punta dentata
Angular, one
blade serrated



0305-1
Fig. 1
Iris
cm. 11,5

Rette
Straight



0305-2
Fig. 2
Iris
Curve
Curved



0305-3
Fig. 3
Iris



0305-1TC
Fig. 1TC
Iris
cm. 11

Rette
Straight



0305-2TC
Fig. 2TC
Iris
cm. 11

Con inserti al carburo
di tungsteno
With tungsten carbide inserts

Dove nasce un sorriso...
Where smile rises...



Forbicine per Gengive

Gum Scissors



0304-1
Fig. 1
Goldman-Fox
cm. 13

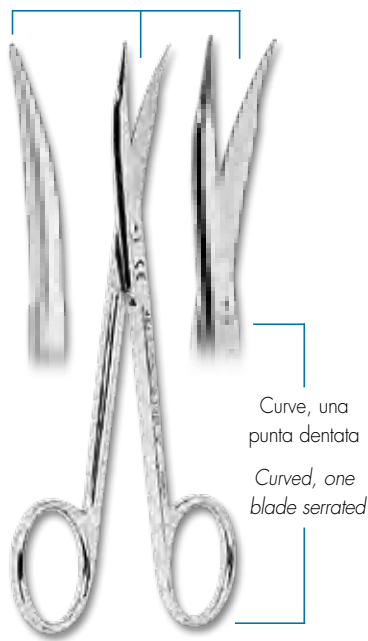

0304-2
Fig. 2
Goldman-Fox
cm. 13



0304-3
Fig. 3
Goldman-Fox (special)
cm. 13

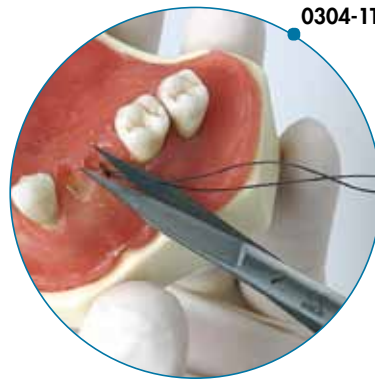

0304-1TC Forbicine dritte Goldman-Fox con inserti al carburo di tungsteno
Goldman-Fox gum scissors with tungsten carbide inserts, straight



0304-1TC
Fig. 1TC
Goldman-Fox
cm. 13

Con inserti al carburo di tungsteno
With tungsten carbide inserts



0304-2TC
Fig. 2TC
Goldman-Fox
cm. 13

Forbicine per Gengive

Gum Scissors

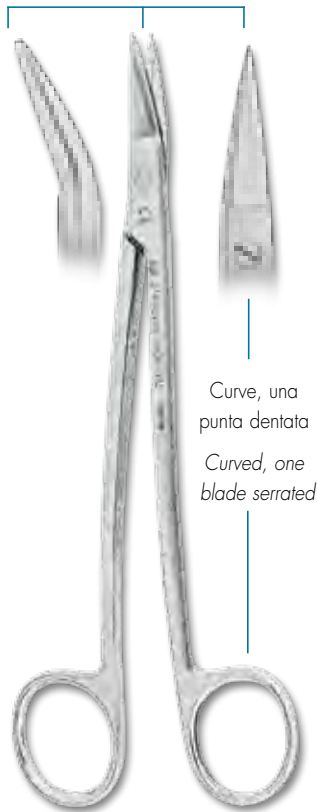

Curve, una punta dentata
Curved, one blade serrated

0306-1
Fig. 1
Dean
cm. 17

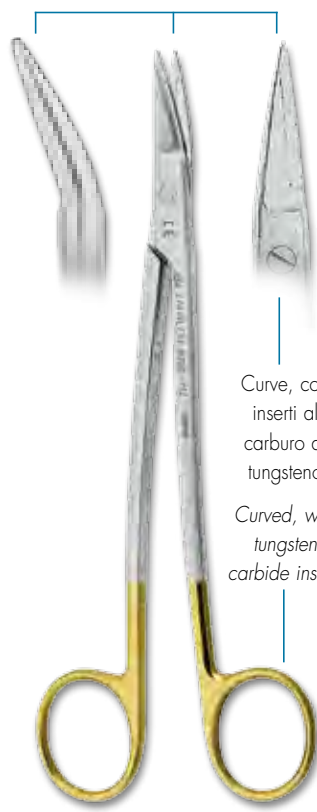

Curve, con inserti al carburo di tungsteno
Curved, with tungsten carbide inserts

0306-1TC
Fig. 1TC
Dean
cm. 17

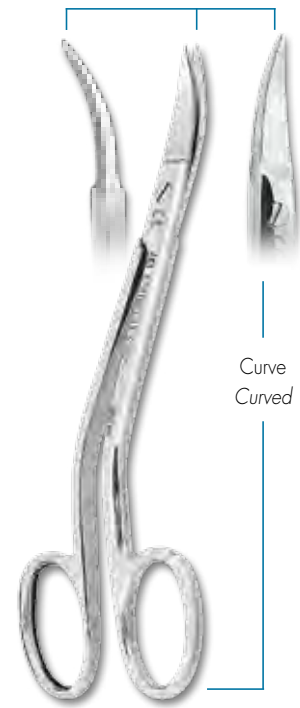

Curve
Curved

0302-1
Fig. 1
Neumann
cm. 12,5



Curve, una punta dentata
Curved, one blade serrated

0307-1
Fig. 1
La Grange
cm. 10,5



Rette
Straight

0308-1
Fig. 1
Quinby
cm. 12,5



Curve
Curved

0308-2
Fig. 2
Quinby
cm. 12,5

*Dove nasce un sorriso...
Where smile rises...*



Forbicine per Gengive

Gum Scissors

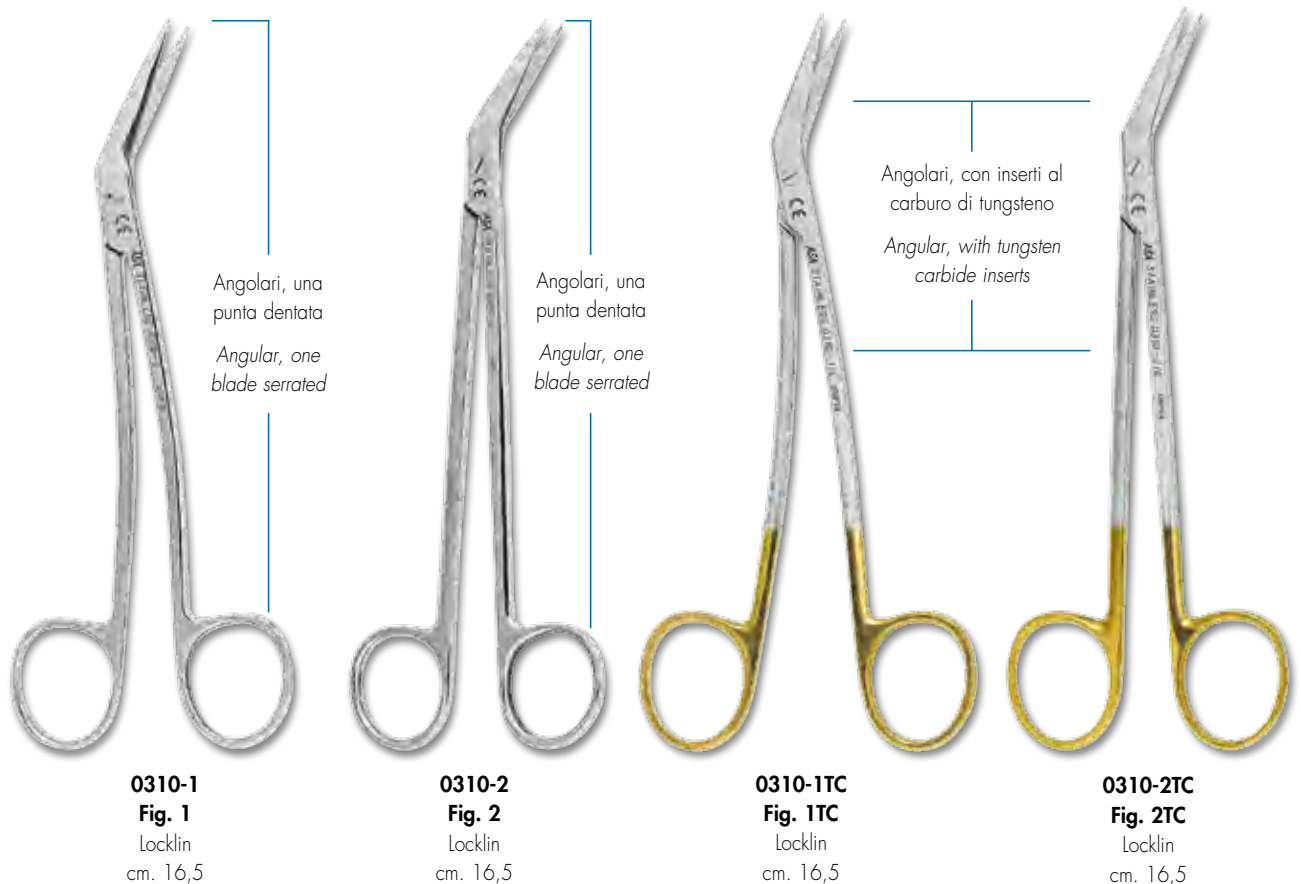
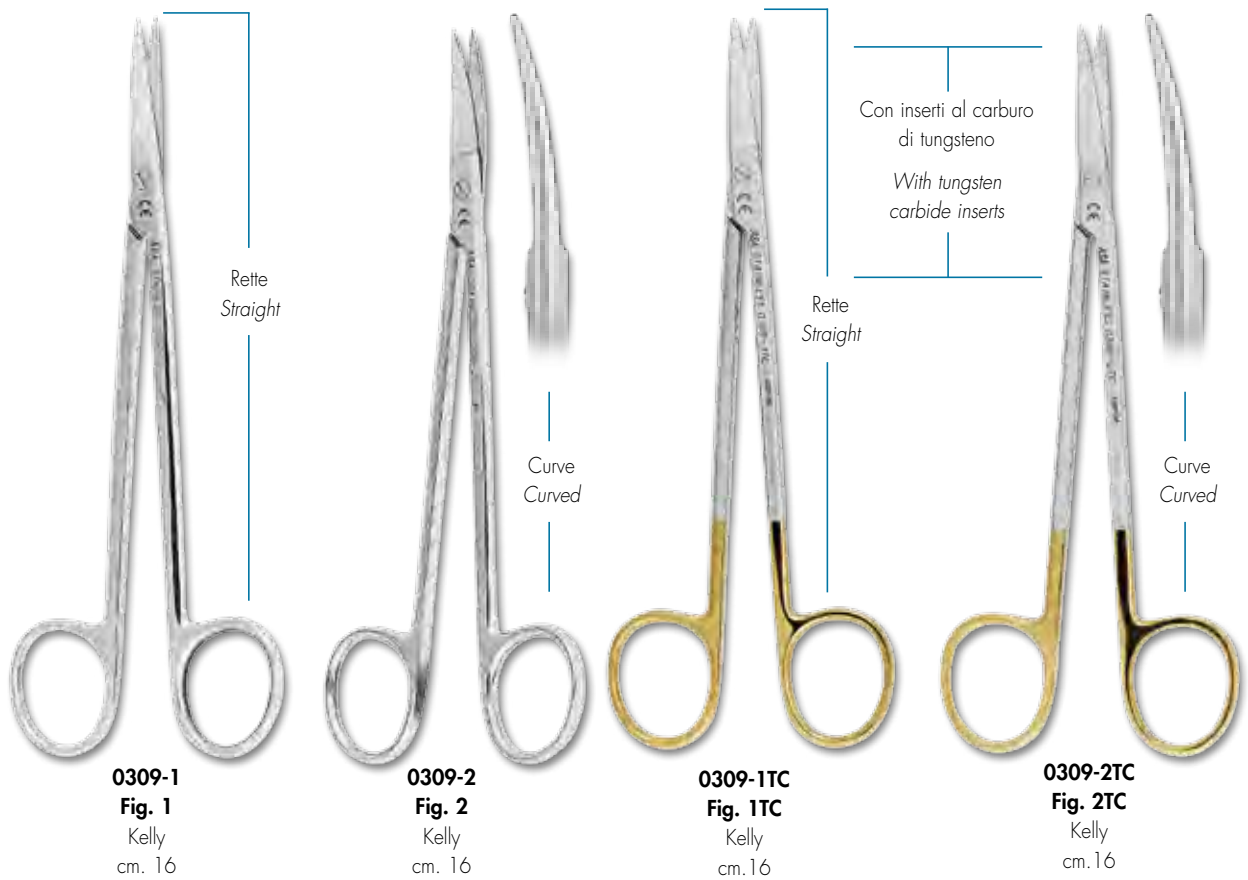

Forbicine per Gengive

Gum Scissors

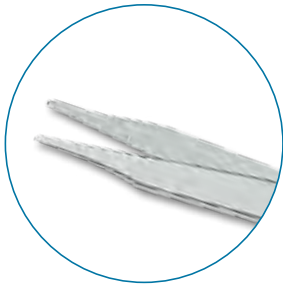

Le forbici ASA Dental garantiscono precisione al taglio e resistenza all'usura.
ASA Dental scissors provide better cutting quality and wear resistance.

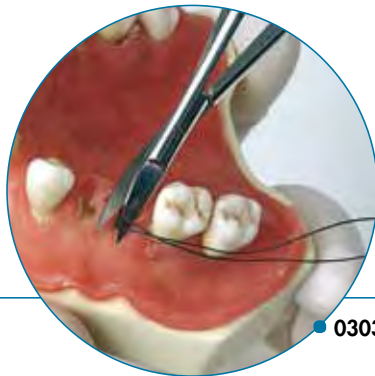

Rette, una punta dentata
Straight, one blade serrated

0311-1
Fig. 1
Sullivan
cm. 14,5

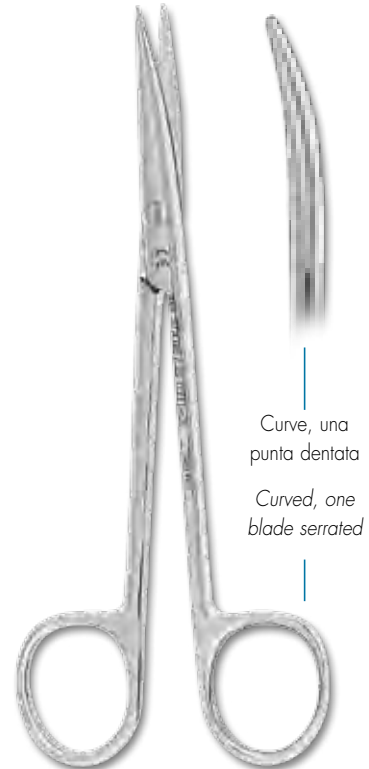

Curve, una punta dentata
Curved, one blade serrated

0311-2
Fig.2
Sullivan
cm. 14,5

● **0303-1** Forbicine per suture Noyes/Castroviejo con punte curve e sottili
Noyes/Castroviejo gum scissors with curved and very fine beaks



Curve, punte molto sottili
Curved, very fine beaks

0303-1
Fig. 1
Noyes (Castroviejo)
cm.12

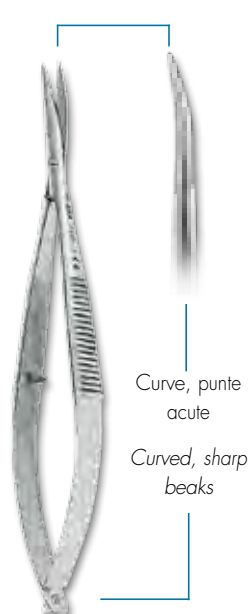

Curve, punte acute
Curved, sharp beaks

0312-1
Fig.1
Westcott
cm.11

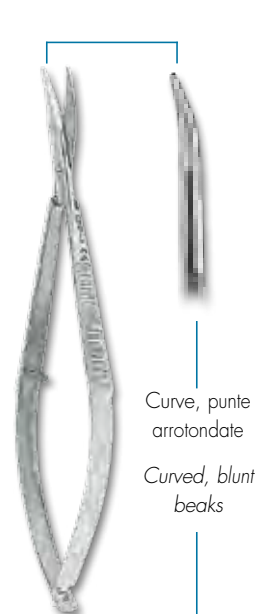

Curve, punte arrotondate
Curved, blunt beaks

0312-2
Fig. 2
Westcott
cm. 11

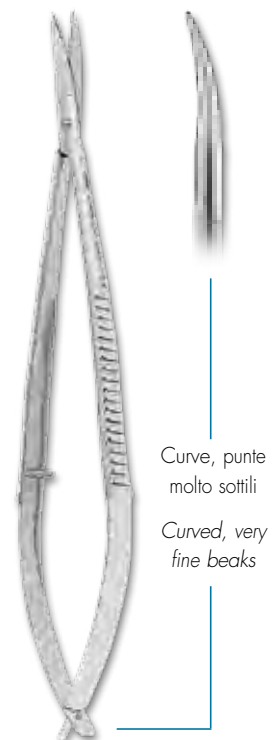

Curve, punte molto sottili
Curved, very fine beaks

0313-1
Fig. 1
cm.14,5

Dove nasce un sorriso...
Where smile rises...



Forbici per Chirurgia

Surgical Scissors

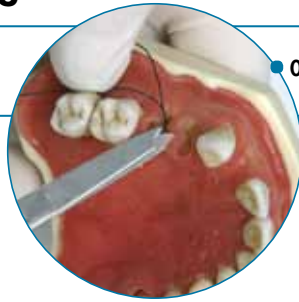

● **0320-2** Forbici di Spencer per suture profonde
Spencer ligature scissors for deep suture

Forbici per legature
Ligature scissors



0320-1
Fig. 1
Spencer
cm.9

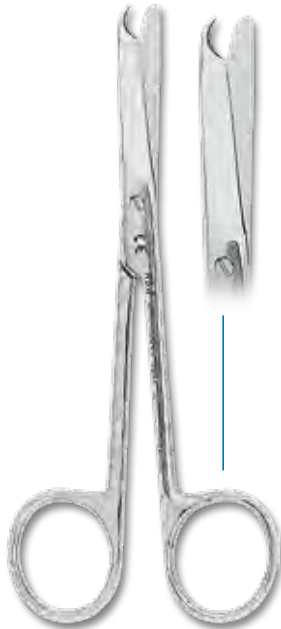

0320-2
Fig. 2
Spencer
cm.13



Rette
Straight

0325-1
Fig. 1
Mayo
cm. 14,5

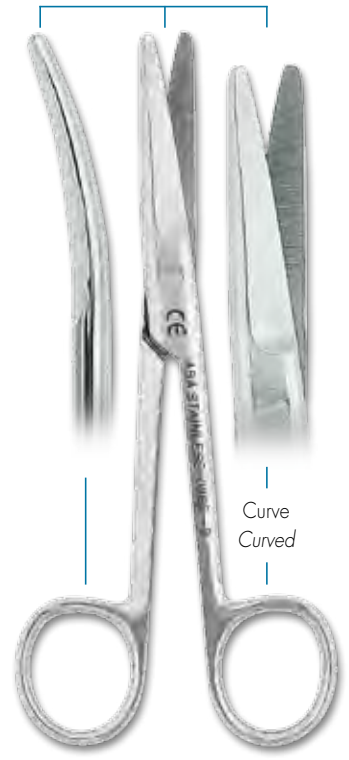

Curve
Curved

0325-2
Fig. 2
Mayo
cm.14,5

■ **Forbici per separazioni**
Dissecting scissors

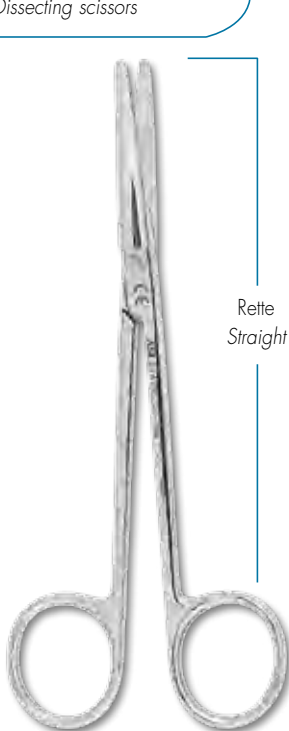

Rette
Straight

0321-1
Fig. 1
Metzenbaum
cm.14,5



Curve
Curved

0321-2
Fig. 2
Metzenbaum
cm.14,5

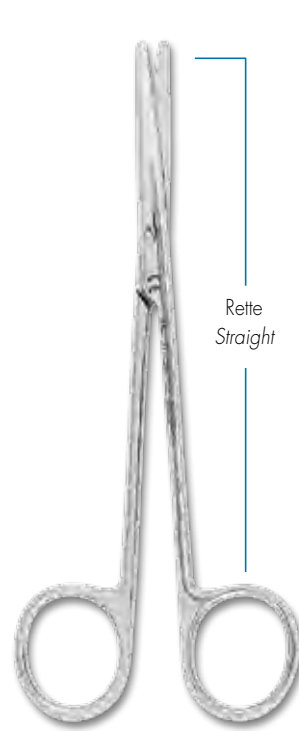

Rette
Straight

0322-1
Fig. 1
Metzenbaum-Delikat
cm. 14,5



Curve
Curved

0322-2
Fig. 2
Metzenbaum-Delikat
cm. 14,5

Dove nasce un sorriso...
Where smile rises...



Forbici per Chirurgia

Surgical Scissors

Forbici per separare Dissecting scissors

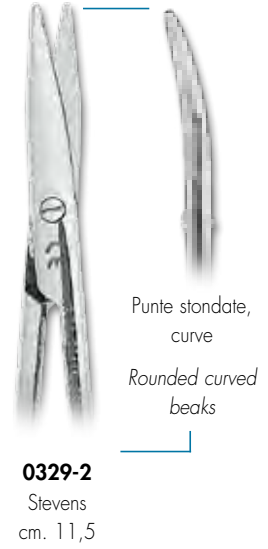
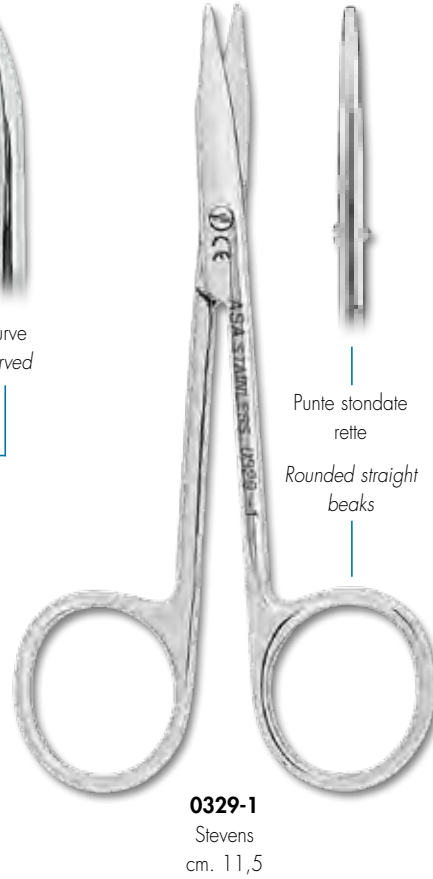
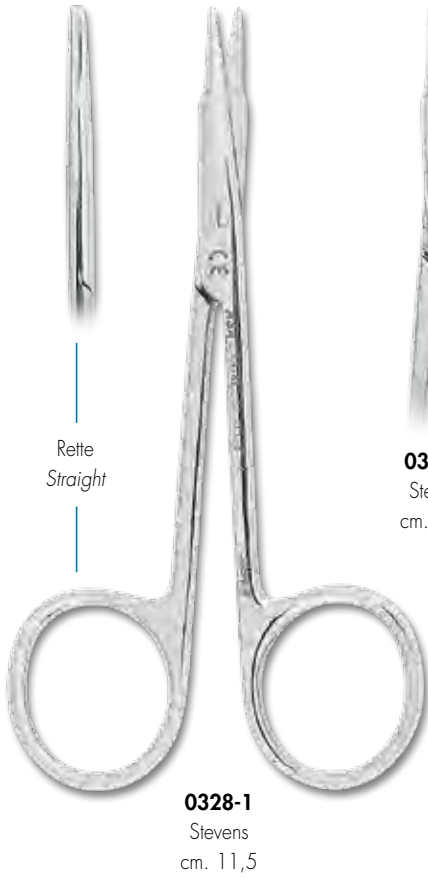

Dove nasce un sorriso...
Where smile rises...



Manici per Bisturi - Lame per Bisturi

Scalpel Handles - Scalpel Blades



0350-3 Manico in acciaio per bisturi
Stainless steel scalpel handle



0350-3
Fig. 3



0350-3G
Fig. 3G



0350-8
Fig. 8



0350-7
Fig. 7



0350-5
Fig. 5



0350-5A
Fig. 5A



0351-12D
Fig. 12D

A doppio taglio
Double cutting edge



0351-15C
Fig. 15C



0351-10
Fig. 10



0351-11
Fig. 11



0351-12
Fig. 12



0351-13
Fig. 13



0351-15
Fig. 15

Confezione da 100 pezzi
Box of 100



Dove nasce un sorriso...
Where smile rises...



Manici per Bisturi - Pinza Toglilame Bisturi

Scalpel Handles - Scalpel Blades Remover



Bisturi a lama orientabile
Orientable blade scalpel handle

0335-1
cm. 16



Pinza togli lama
Scalpel blade remover

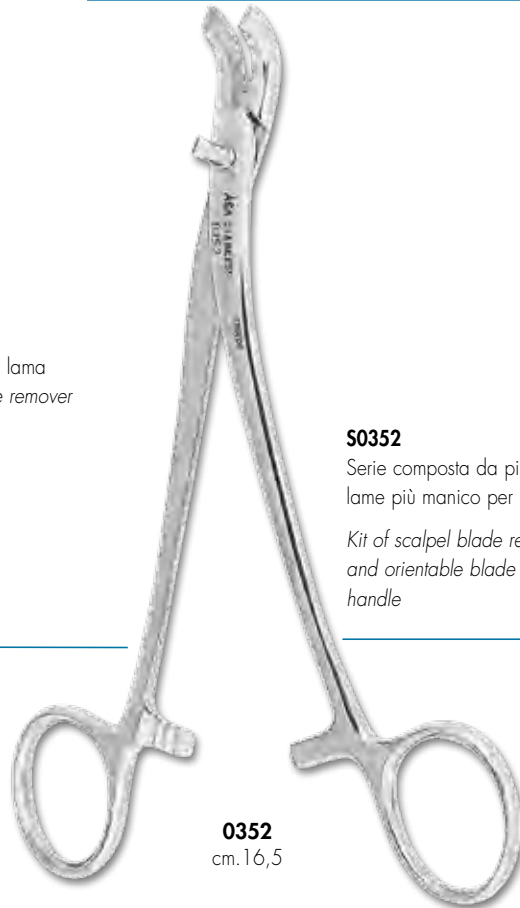

S0352

Serie composta da pinza togli-lama più manico per bisturi

Kit of scalpel blade remover and orientable blade scalpel handle

0352
cm. 16,5

■ Bisturi monouso

Disposable scalpels



0371-10



0371-11



0371-12



0371-15

Confezioni da 10 pz.
Box of 10

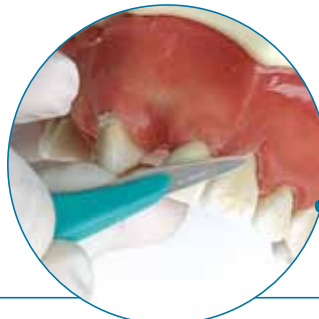

0371-11 Bisturi monouso
Disposable scalpel

Manici per Bisturi - Lame per Bisturi

Scalpel Handles - Scalpel Blades

*Dove nasce un sorriso...
Where smile rises...*



0360-4
Fig. 4



0361-20
Fig. 20



0361-21
Fig. 21



0361-22
Fig. 22



0361-23
Fig. 23



0361-24
Fig. 24

Confezione da 100 lame
Box of 100 blades

Manico per micro lame

Micro-Blade holder

0365-1 Manico per microlame
con bisturi fig.7
Handle for micro-blade
with blade fig.7

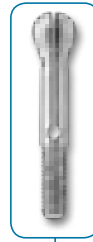

0365-1
cm. 13,5



0366-4
Fig. 4



0366-7
Fig. 7

Micro lame per bisturi
conf. da 25 pezzi sterili

Micro-Blades for micro-blade
holder box of 25 sterile

Dove nasce un sorriso...
Where smile rises...



Porta Aghi

Needle Holders

0400-14 Porta aghi Olsen-Hegar con forbici
Olsen-Hegar needle holder
and scissors combined

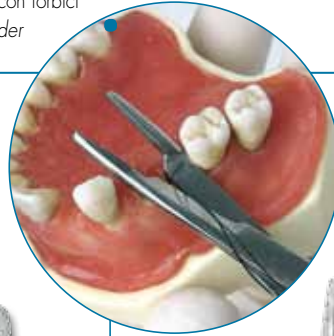

■ Porta aghi con forbice

Needle holders and scissors combined

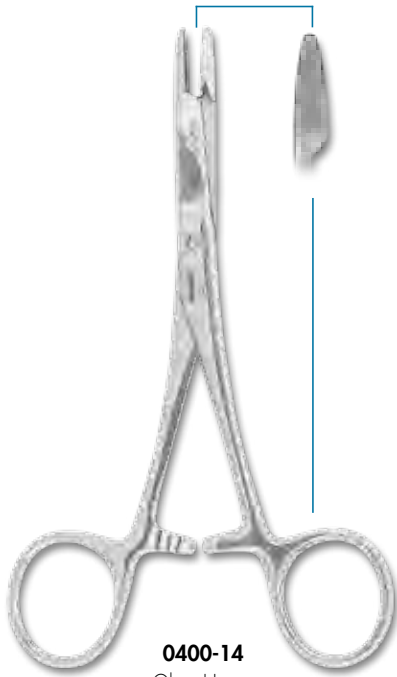

0400-14
Olsen-Hegar
cm. 14

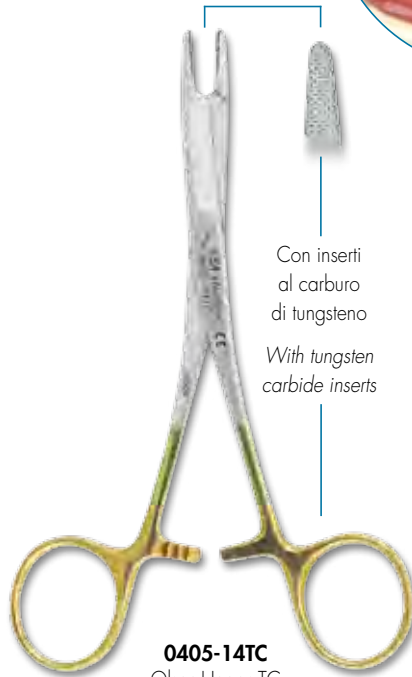

Con inserti
al carburo
di tungsteno
With tungsten
carbide inserts

0405-14TC
Olsen-Hegar TC
cm. 14

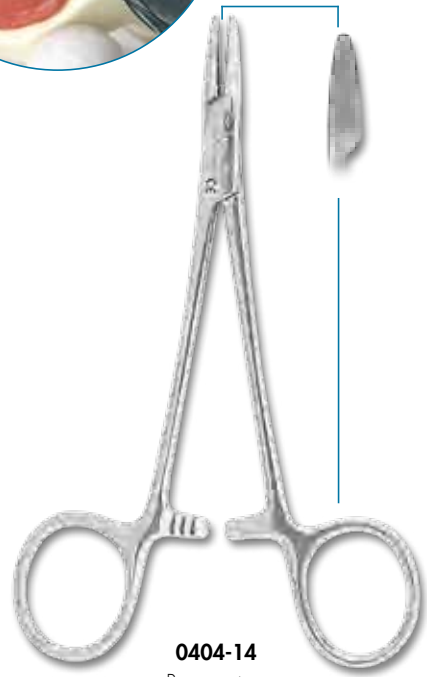

0404-14
Baumgartner
cm. 14,5



0410-15
Crile-Wood
cm. 15

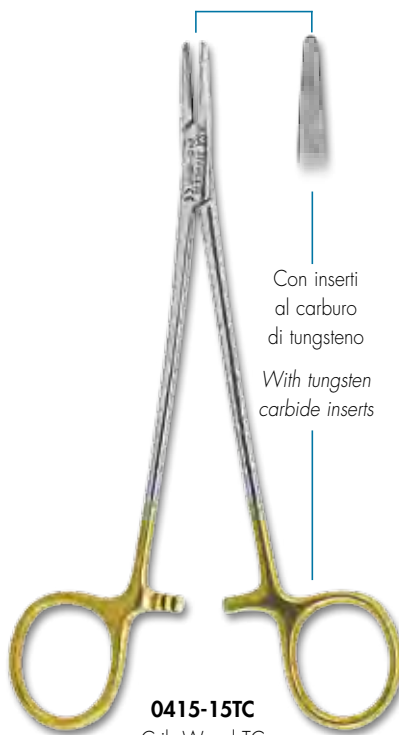

Con inserti
al carburo
di tungsteno
With tungsten
carbide inserts

0415-15TC
Crile-Wood TC
cm. 15



0403-17
Adson
cm. 17,5

Dove nasce un sorriso...
Where smile rises...



Porta Aghi

Needle Holders

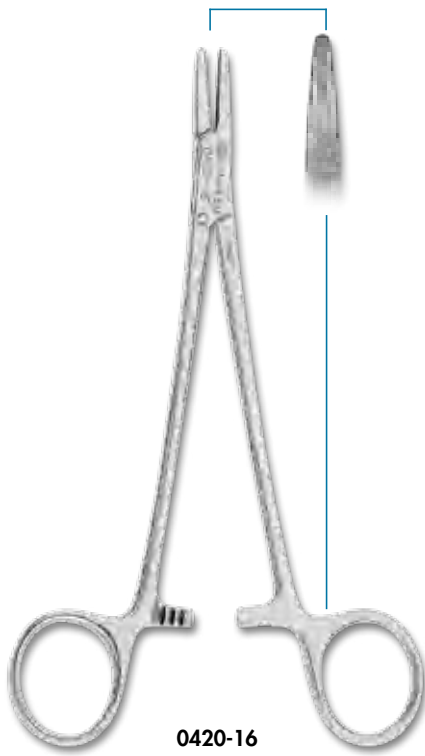

0420-16
Mayo-Hegar
cm. 16



0425-16TC
Mayo-Hegar TC
cm. 16

Con inserti
al carburo
di tungsteno
*With tungsten
carbide inserts*

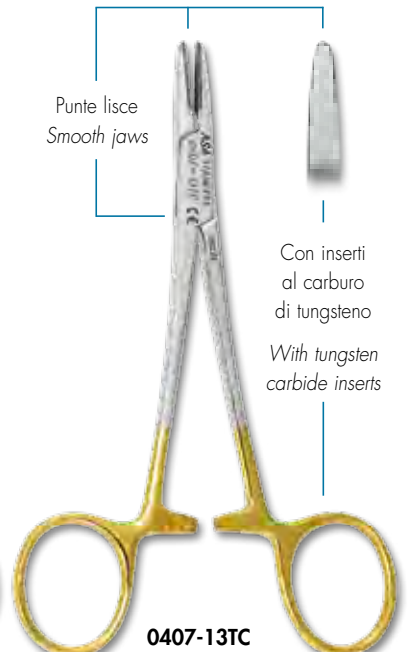

0407-13TC
Halsey-Smooth
cm. 13

Punte lisce
Smooth jaws

Con inserti
al carburo
di tungsteno
*With tungsten
carbide inserts*



0420-18
Mayo-Hegar
cm. 18



0425-18TC
Mayo-Hegar TC
cm. 18

Con inserti
al carburo
di tungsteno
*With tungsten
carbide inserts*

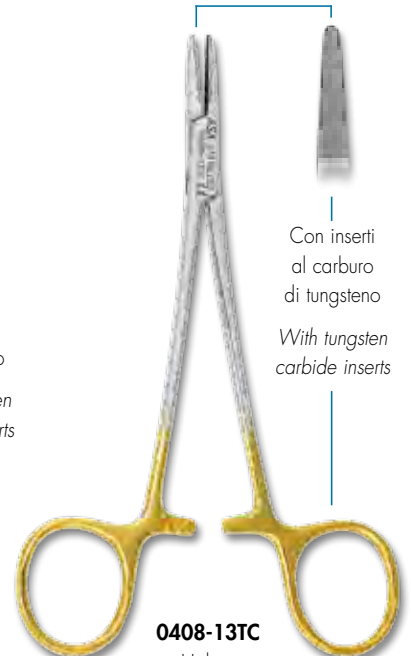

0408-13TC
Halsey
cm. 13

Con inserti
al carburo
di tungsteno
*With tungsten
carbide inserts*

Dove nasce un sorriso...
Where smile rises...



Porta Aghi

Needle Holders

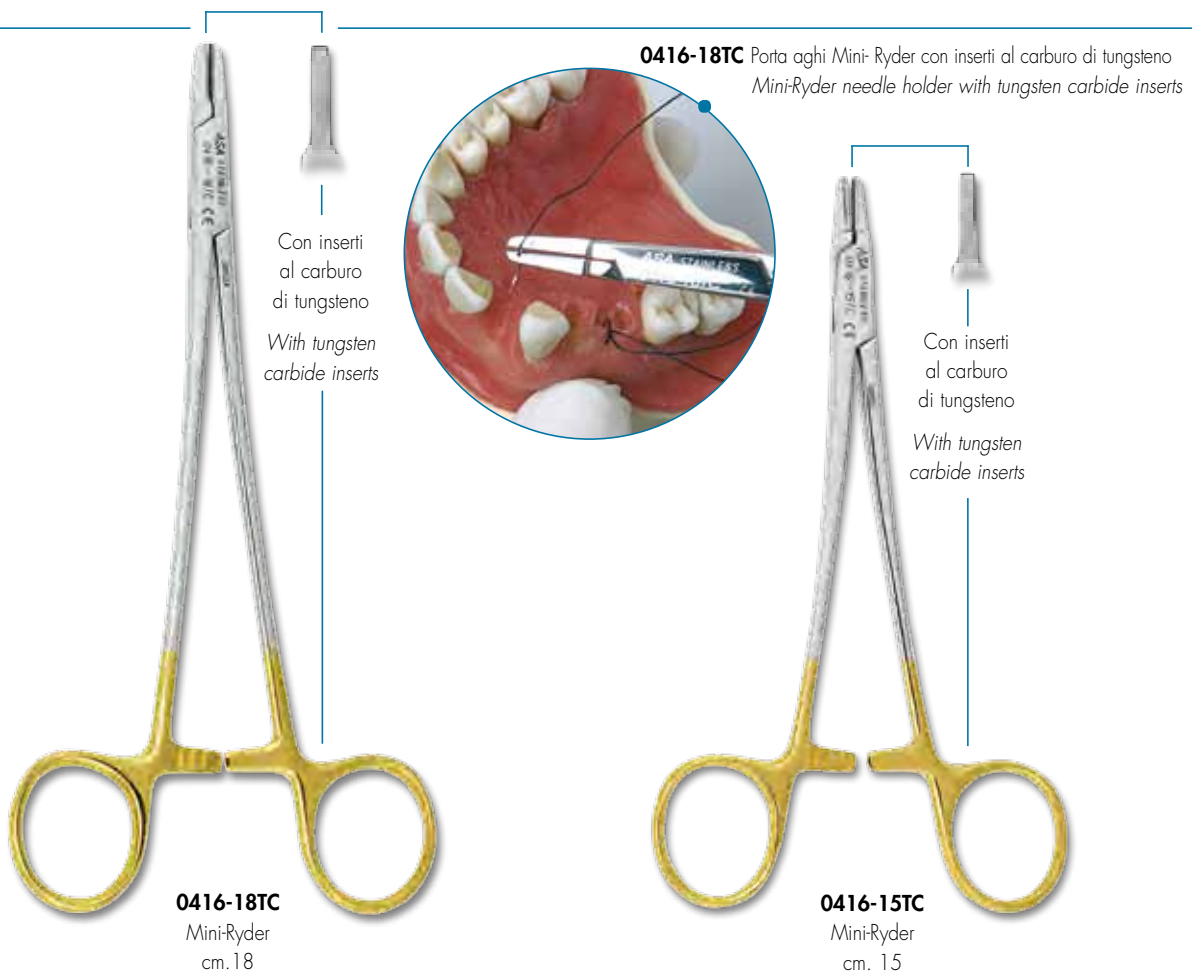
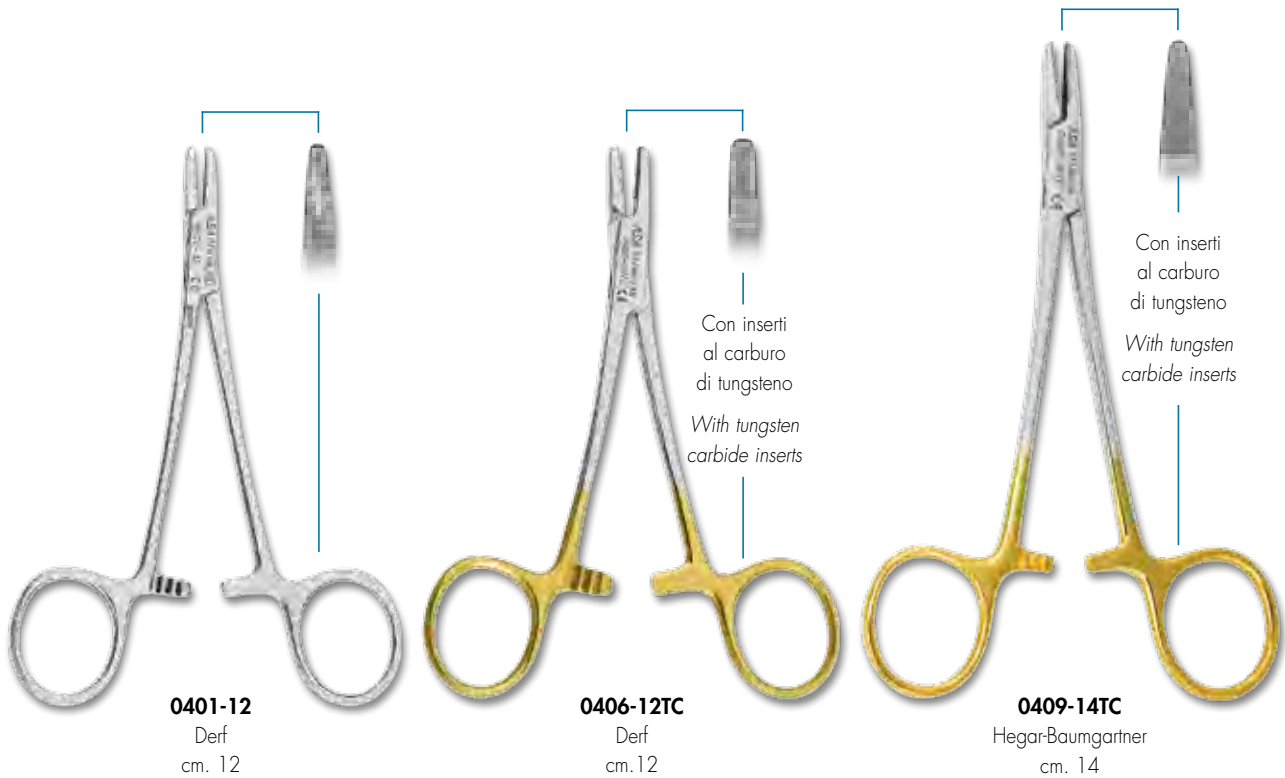

Dove nasce un sorriso...
Where smile rises...



Porta Aghi

Needle Holders

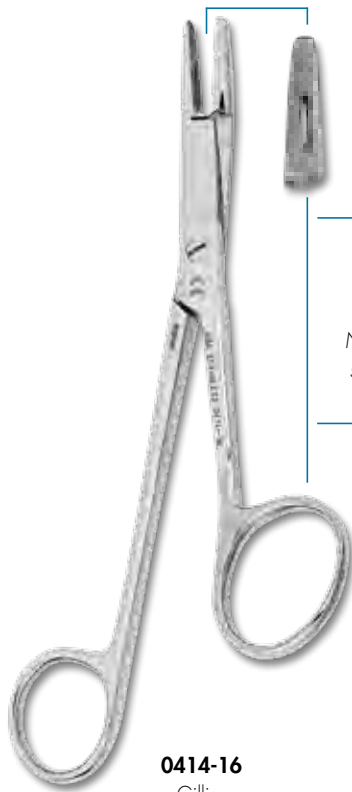

0414-16
Gillies
cm. 16

Porta aghi
con forbice
*Needle holder and
scissors combined*

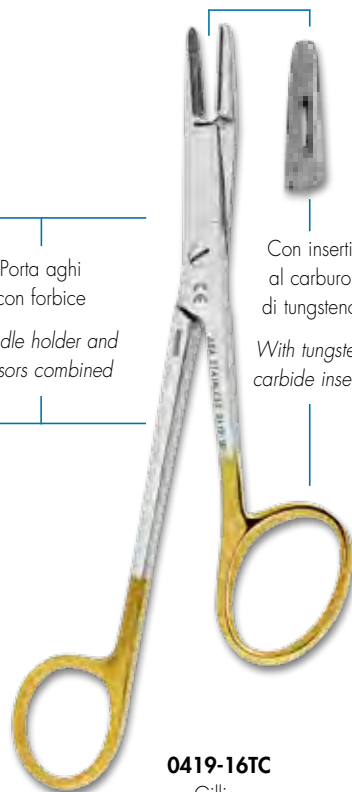

0419-16TC
Gillies
cm. 16

Con inserti
al carburo
di tungsteno
*With tungsten
carbide inserts*

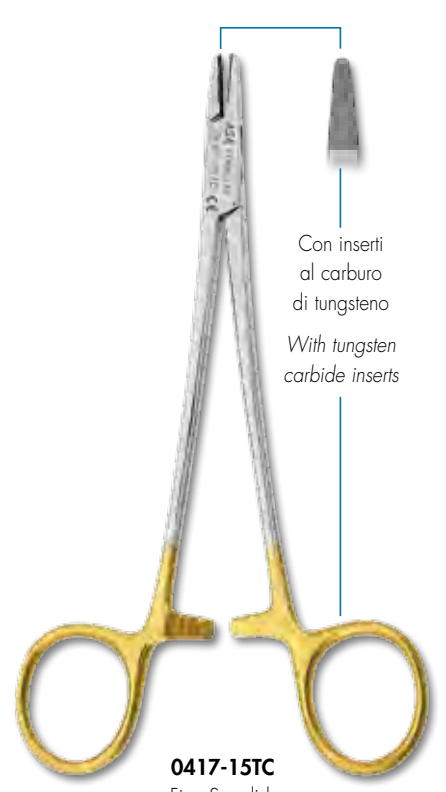

0417-15TC
Fine Swedish
cm. 15

Con inserti
al carburo
di tungsteno
*With tungsten
carbide inserts*

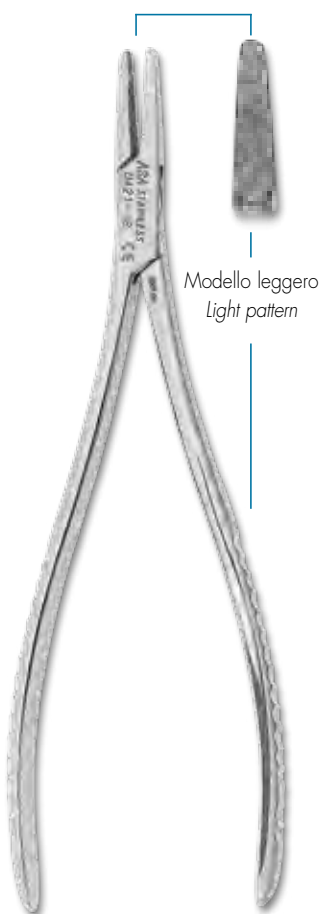

0421-18
Toennis
cm. 18

Modello leggero
Light pattern

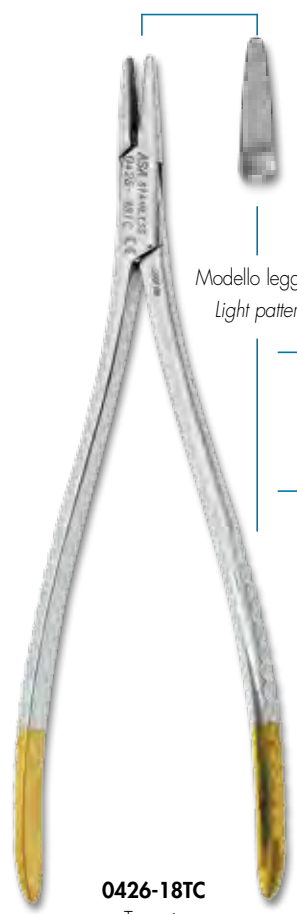

0426-18TC
Toennis
cm. 18

Modello leggero
Light pattern

Con inserti al carburo di tungsteno
With tungsten carbide inserts



0418-15TC
Micro-Vascular
cm. 15

Dove nasce un sorriso...
Where smile rises...



Porta Aghi

Needle Holders



Movimento
leggero
Smooth action

0432-17
Lichtenberg
cm. 17

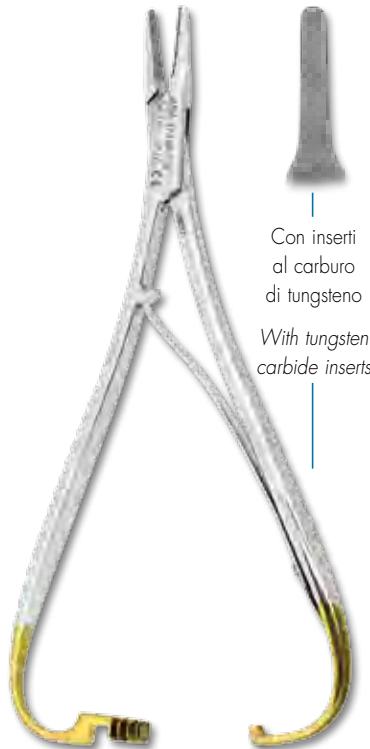

Con inserti
al carburo
di tungsteno
With tungsten
carbide inserts

0437-17TC
Lichtenberg
cm. 17

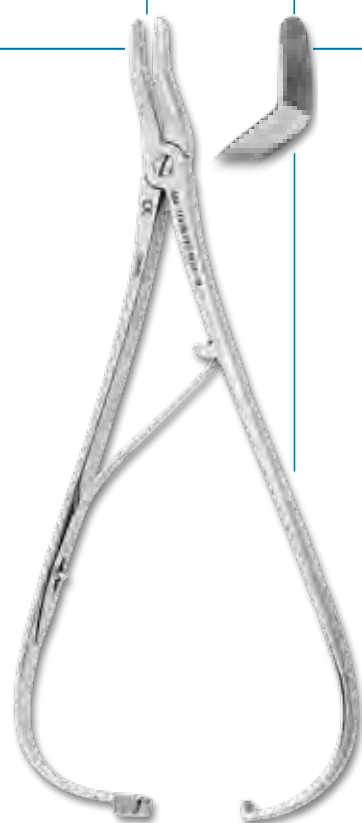

0422-19
Eiselberg-Mathieu
cm. 19,5



0433-16
Arruga
cm. 16



Con inserti
al carburo
di tungsteno
With tungsten
carbide inserts

0438-16TC
Arruga
cm. 16

Dove nasce un sorriso...
Where smile rises...



Porta Aghi

Needle Holders

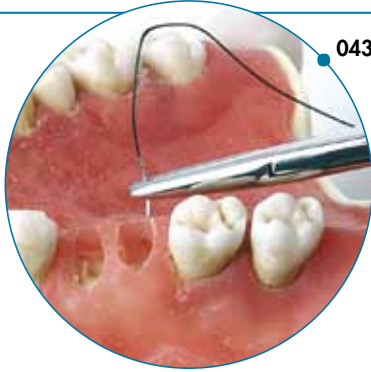

0430-14 Porta aghi Mathieu con punte molto sottili
Mathieu needle holder with very fine jaws

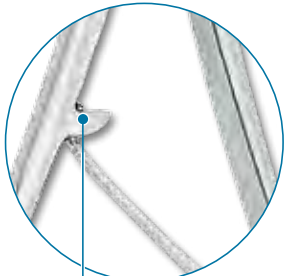

● Porta aghi prodotti con molle progettate per garantire una massima funzionalità e durata nel tempo.

Special spring design for optimum operation and reliability.



0430-14
Mathieu
cm. 14

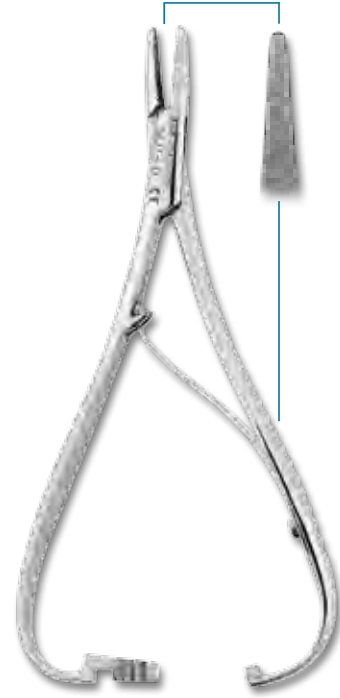

0431-14
Mathieu
cm. 14

Porta aghi con forbice
Needle holder and scissors combined



0432-14
Mathieu
cm. 14

Con inserti al carburo di tungsteno
With tungsten carbide inserts



0432-14TC
Mathieu
cm. 14

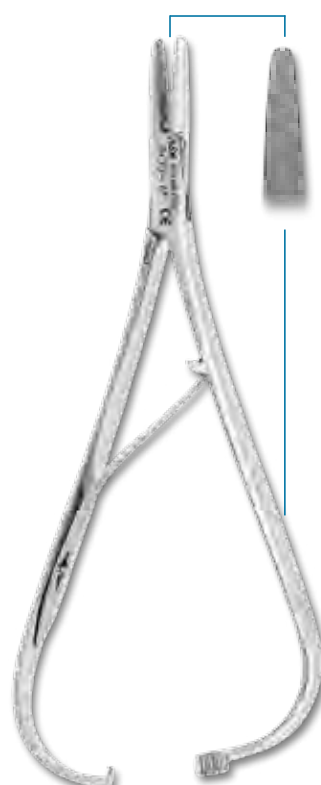

0430-17
Mathieu
cm. 17



0431-17
Mathieu
cm. 17

Dove nasce un sorriso...
Where smile rises...

ASA DENTAL®

Porta Aghi

Needle Holders

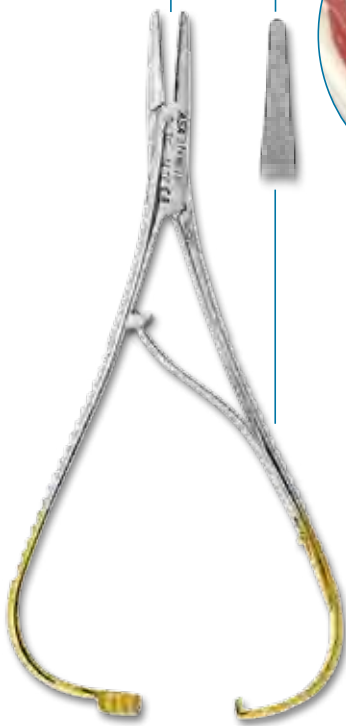
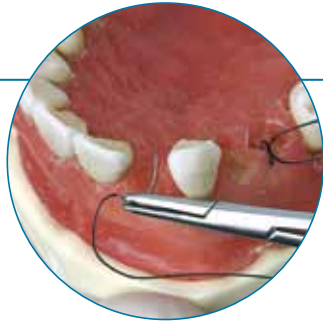

0436-14TC
Mathieu TC
cm. 14



0435-14TC
Mathieu TC
cm. 14



0450-18TC
Micro-Barraquer TC
cm. 18

Con inserti al carburo
di tungsteno

With tungsten carbide
inserts



0436-17TC
Mathieu TC
cm. 17

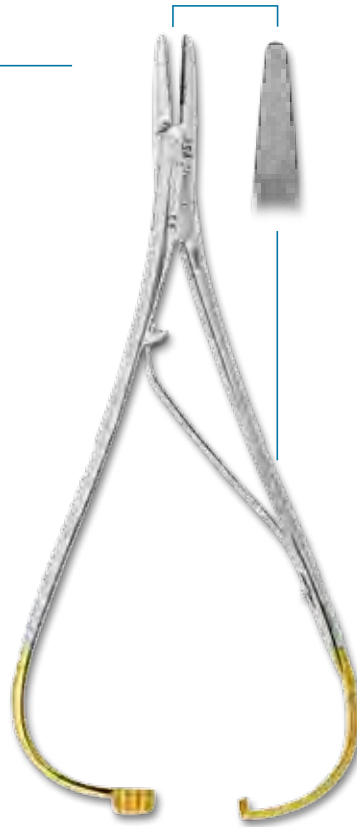

0435-17TC
Mathieu TC
cm. 17

Con punte
curve
With curved
jaws

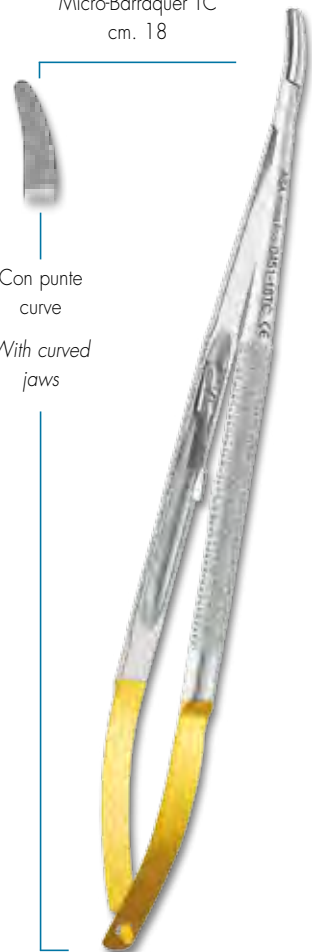

0451-18TC
Micro-Barraquer TC
cm. 18

*Dove nasce un sorriso...
Where smile rises...*



Porta Aghi

Needle Holders



0440-14
Castroviejo
cm. 14

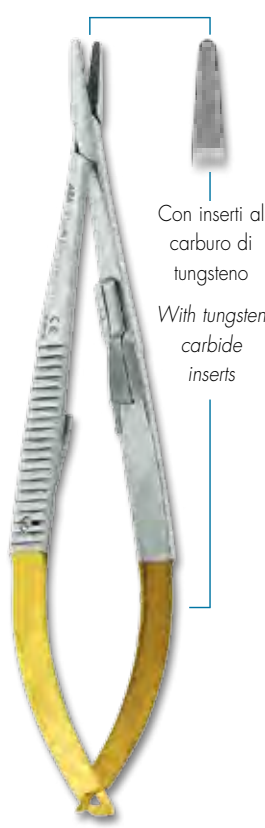

0445-14TC
Castroviejo TC
cm. 14



0443-14
Castroviejo
cm. 14/60°

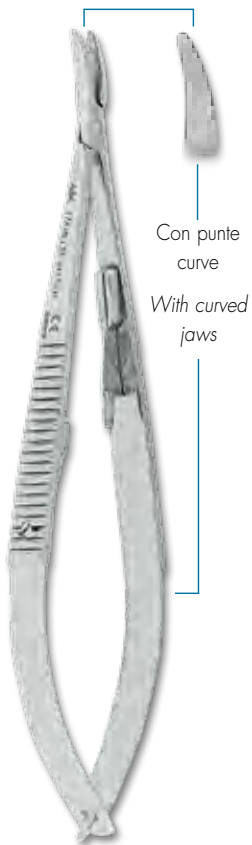

0441-14
Castroviejo
cm. 14

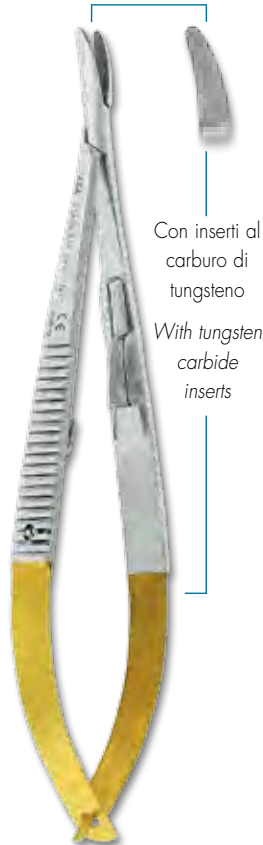

0446-14TC
Castroviejo TC
cm. 14

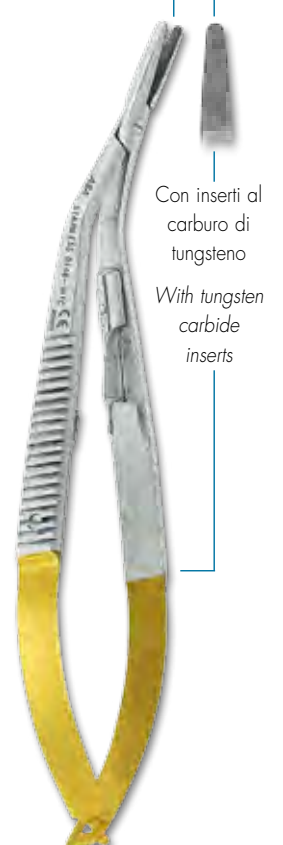

0448-14TC
Castroviejo TC
cm. 14/60°

Dove nasce un sorriso...
Where smile rises...



Porta Aghi

Needle Holders



0440-18

Castroviejo
cm. 18

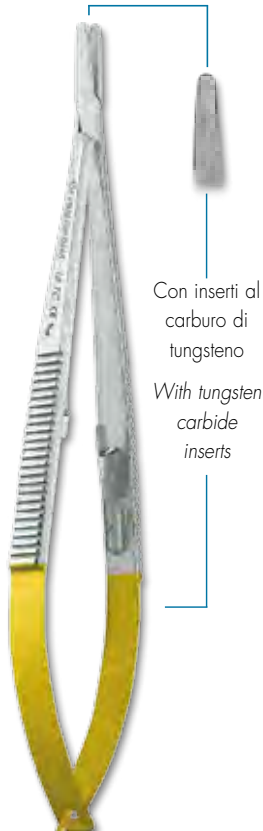

0445-18TC

Castroviejo
cm. 18

Con inserti al
carburo di
tungsteno
With tungsten
carbide
inserts

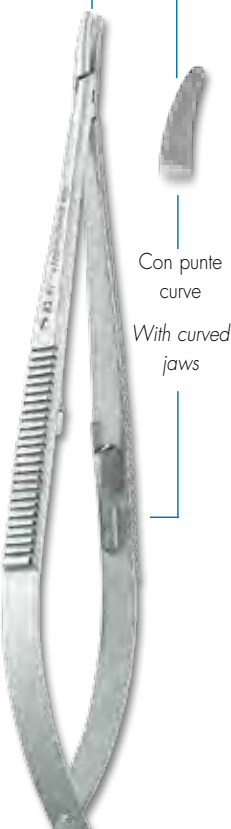

0441-18

Castroviejo
cm. 18

Con punte
curve
With curved
jaws

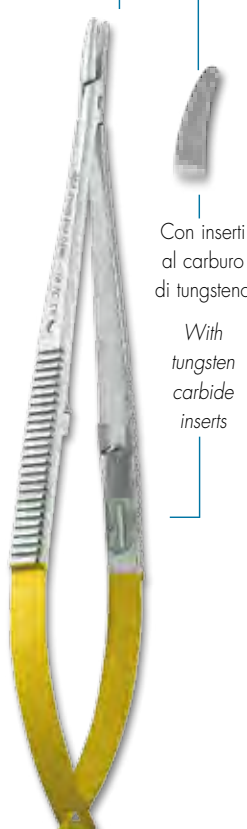

0446-18TC

Castroviejo
cm. 18

Con inserti
al carburo di
tungsteno
With tungsten
carbide
inserts

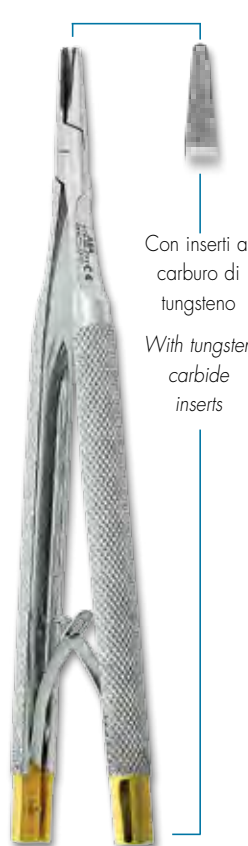

0447-13TC

Castroviejo
cm. 13

Con inserti al
carburo di
tungsteno
With tungsten
carbide
inserts

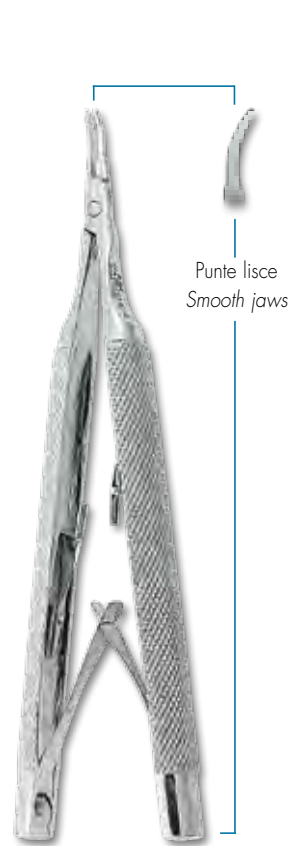

0444-12L

Castroviejo-Barraquer
cm. 12

Punte lisce
Smooth jaws

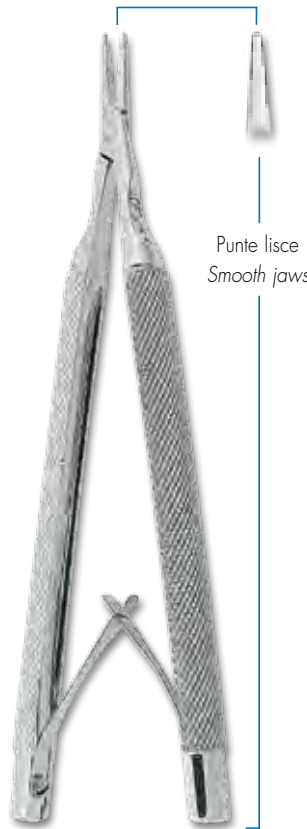

0442-13L

Castroviejo
cm. 13

Punte lisce
Smooth jaws



0442-13

Castroviejo
cm. 13

*Dove nasce un sorriso...
Where smile rises...*



Siringhe per Anestesia Intraligamentale

Intra-Ligamental Syringes



Siringa in acciaio inox
Stainless steel syringe

0481-8

0481-8 Siringa per anestesia intraligamentale
Intra-ligamental syringe

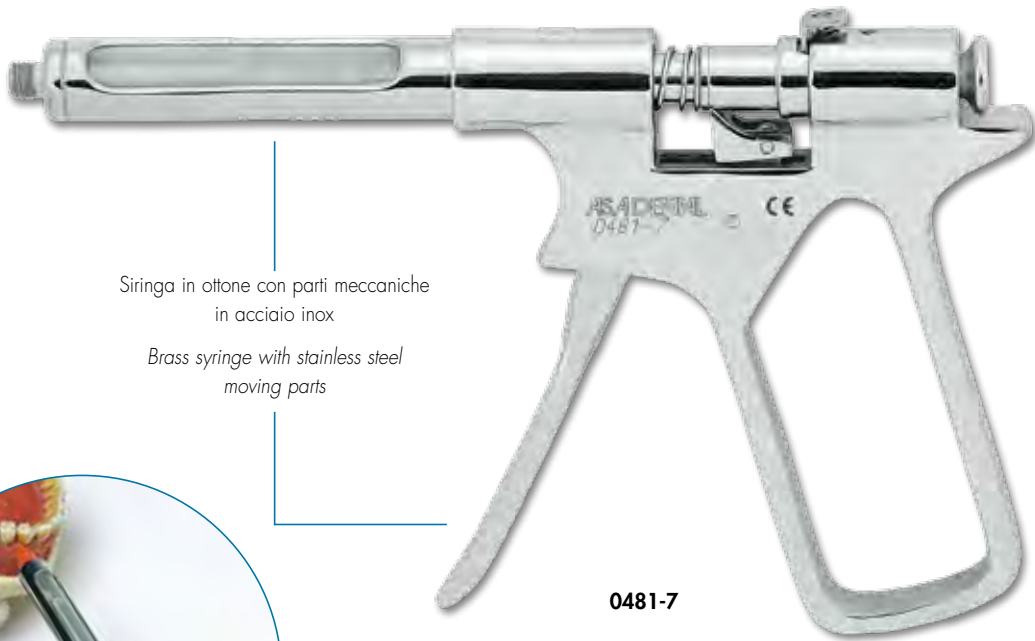

Siringa in ottone con parti meccaniche
in acciaio inox

*Brass syringe with stainless steel
moving parts*

0481-7

0481-7 Siringa per anestesia intraligamentale
Intra-ligamental syringe



0481-T1

Protezione in plastica autoclavabile
Autoclavable plastic protection sleeve



0482-1

Base di appoggio per siringa
Syringe stand

Siringhe Dentali

Dental Syringes

0480-1 Siringa a tre anelli con ago montato
3 ring syringes with needle

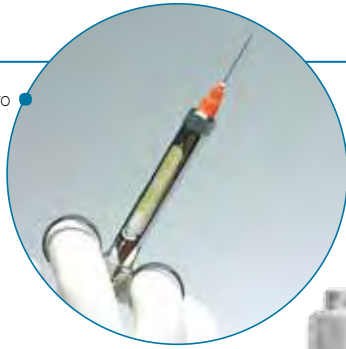

0480-3 Caricamento della tubo fiala
Phial-pipe setting



Puntali a cavatappi
Cork screw tip



0480-1



0480-2

Pieghevole, puntale
a cavatappi
Folding type, cork
screw tip



0480-3

0480-P1
Puntale di ricambio
filettatura metrico decimale
Spare cap with metric thread



Puntale a
cavatappi
Cork screw
tip



0480-4

0480-P2
Puntale di ricambio
filettatura Withworth
Spare cap with
Withworth thread



Siringhe autoaspiranti
con filettatura metrico
decimale
Self aspirating syringes
with metric thread



0480-5



0480-6

Dove nasce un sorriso...
Where smile rises...



Pinze Emostatiche

Haemostatic Forceps



Rette
Straight

0520-1
Fig. 1
Crile
cm. 14

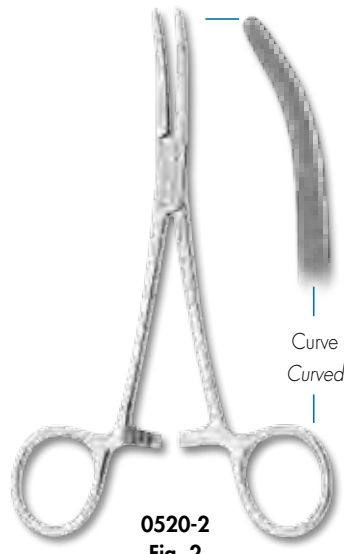

Curve
Curved

0520-2
Fig. 2
Crile
cm. 14



0530-1

Pinzetta emostatica portagarze
Kocher

*Kocher haemostatic forceps also
for bandages*



Rette
Straight

0530-1
Fig. 1
Kocher 1x2
cm. 14

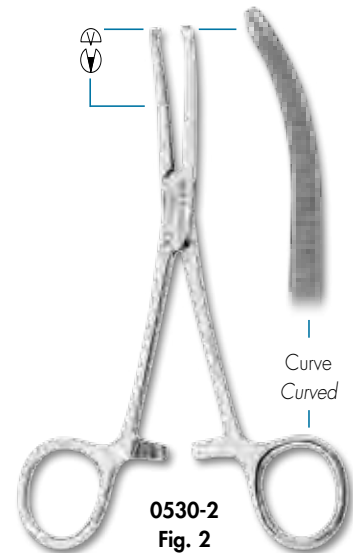

Curve
Curved

0530-2
Fig. 2
Kocher 1x2
cm. 14

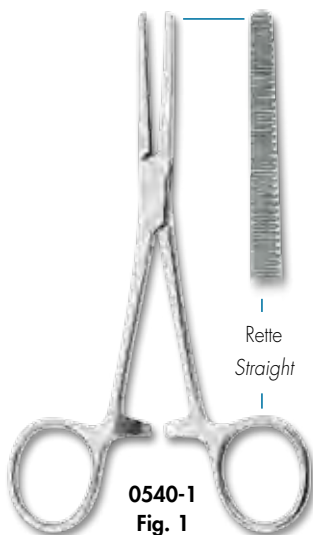

Rette
Straight

0540-1
Fig. 1
Pean
cm. 14



Curve
Curved

0540-2
Fig. 2
Pean
cm. 14

Dove nasce un sorriso...
Where smile rises...



Pinze Emostatiche

Haemostatic Forceps

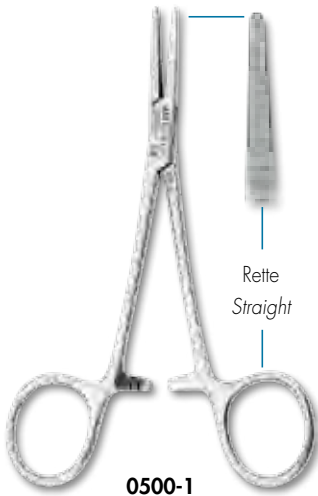

Rette
Straight

0500-1
Fig. 1
Halstead-Mosquito
cm. 12

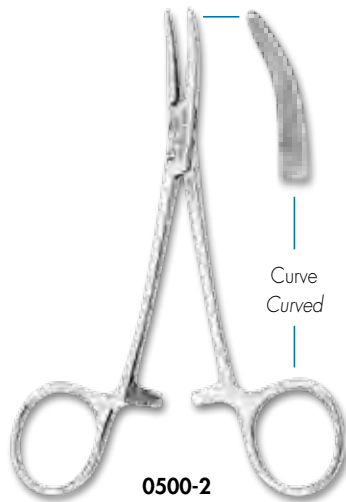

Curve
Curved

0500-2
Fig. 2
Halstead-Mosquito
cm. 12

0500-1 Pinza emostatica portagarze Halstead-Mosquito
Halstead-Mosquito haemostatic forceps

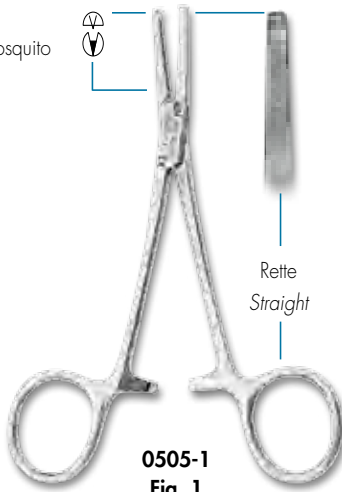
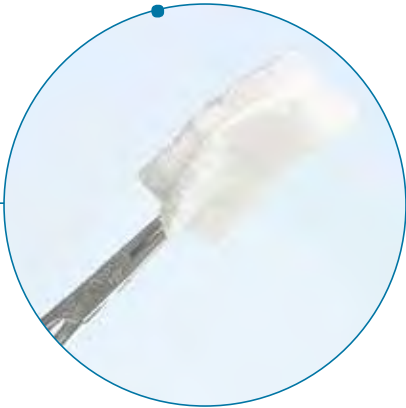

Rette
Straight

0505-1
Fig. 1
Halstead-Mosquito 1x2
cm. 12

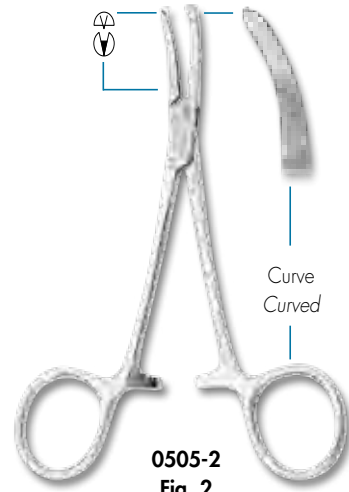

Curve
Curved

0505-2
Fig. 2
Halstead-Mosquito 1x2
cm. 12



Rette
Straight

0510-1
Fig. 1
Kelly
cm. 14

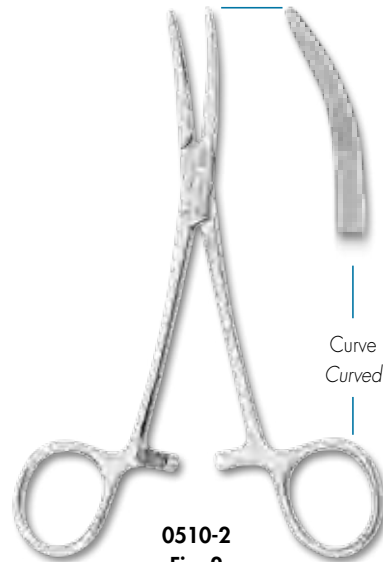

Curve
Curved

0510-2
Fig. 2
Kelly
cm. 14

Dove nasce un sorriso...
Where smile rises...



Pinze Emostatiche

Haemostatic Forceps



Rette
Straight

0501-1
Fig. 1
Micro-Mosquito
cm. 10

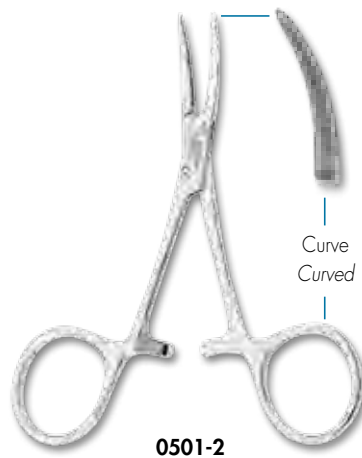

Curve
Curved

0501-2
Fig. 2
Micro-Mosquito
cm. 10

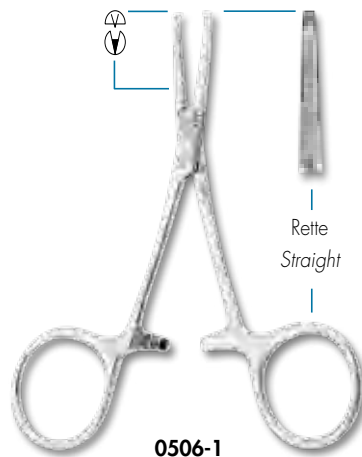

Rette
Straight

0506-1
Fig. 1
Micro-Mosquito 1x2
cm. 10

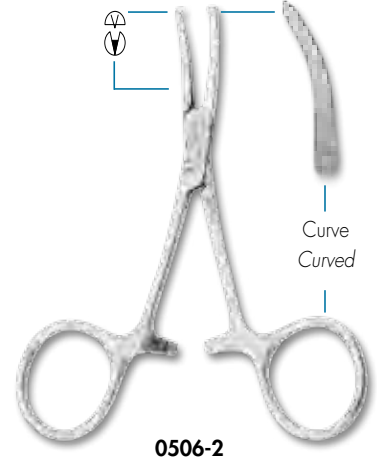

Curve
Curved

0506-2
Fig. 2
Micro-Mosquito 1x2
cm. 10



Rette
Straight

0515-1
Fig. 1
Hartmann
cm. 10



Curve
Curved

0515-2
Fig. 2
Hartmann
cm. 10

Dove nasce un sorriso...
Where smile rises...



Pinze per Pannilino

Towel Clamps



0550-1
Fig. 1
Backhaus
cm. 8



0550-2
Fig. 2
Backhaus
cm. 11



0550-3
Fig. 3
Backhaus
cm. 13



0680
Schaedle
cm. 9



0681
Jones
cm. 9

*Dove nasce un sorriso...
Where smile rises...*



Pinze Porta Tamponi

Dressing Forceps

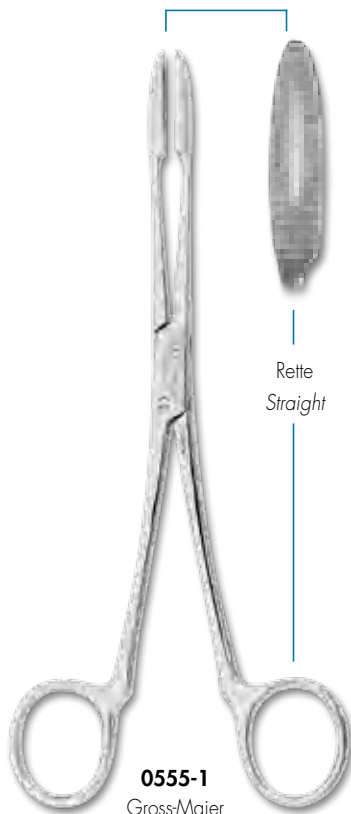

0555-1
Gross-Maier
cm. 20

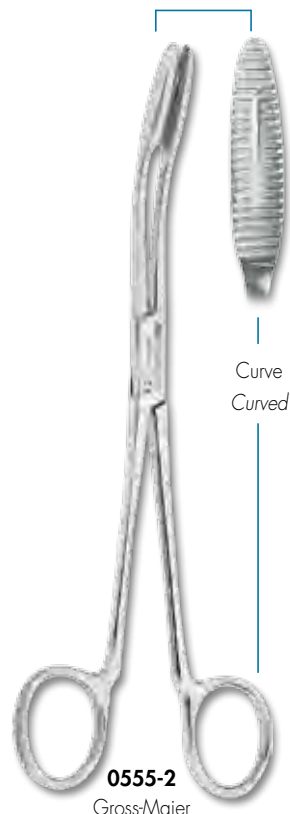

0555-2
Gross-Maier
cm. 20

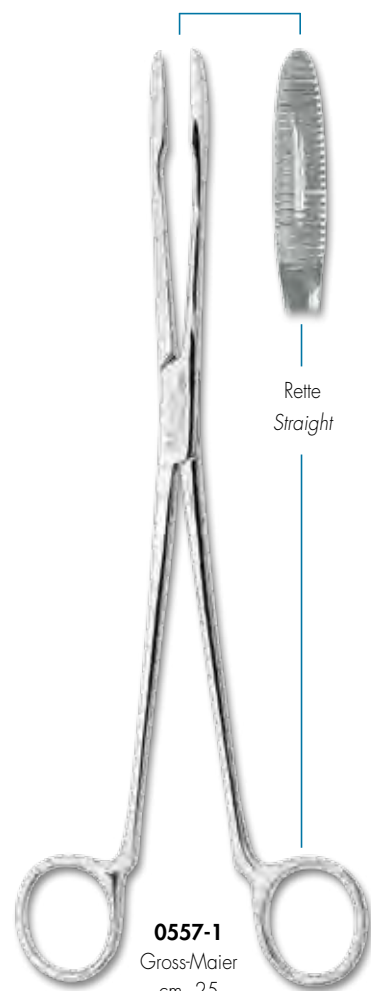

0557-1
Gross-Maier
cm. 25

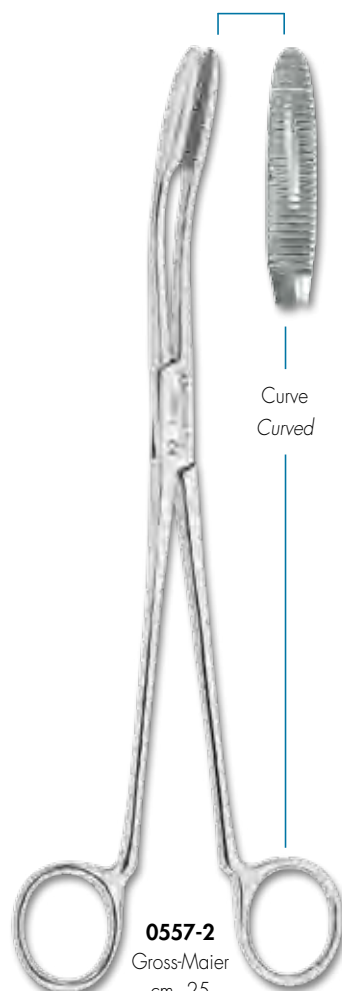

0557-2
Gross-Maier
cm. 25

Dove nasce un sorriso...
Where smile rises...



Apribocca - Pinze Tiralingua

Mouth Gags - Tongue Forceps

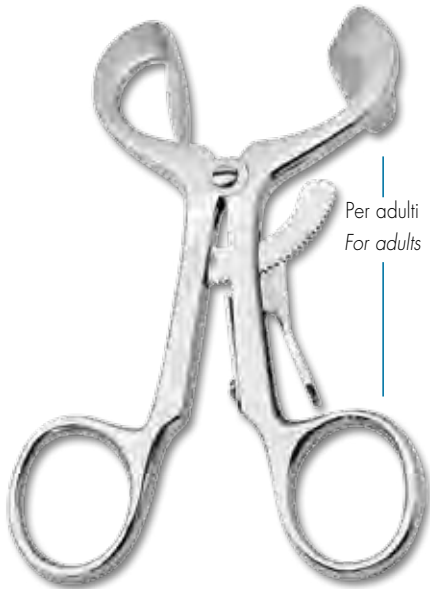

Per adulti
For adults

1870-2
Molt
cm. 14



Per bambini
For children

1870-1
Molt
cm. 11



1871-1
Roser-Koenig
cm. 16



1871-2
Roser-Koenig
cm. 19



0560
Collin
cm. 16

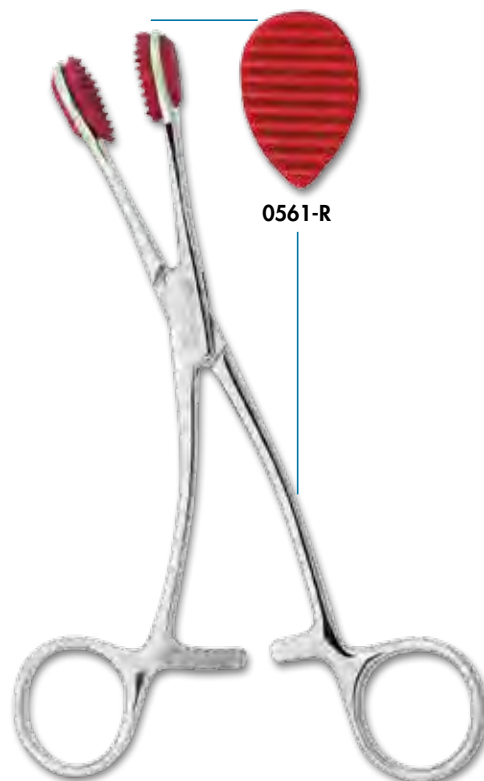

0561
Young
cm. 17

Dove nasce un sorriso...
Where smile rises...

ASA DENTAL®

Divaricatori Abbassalingua

Retractors - Tongue Depressors

■ Divaricatori per labbra

Lip retractors

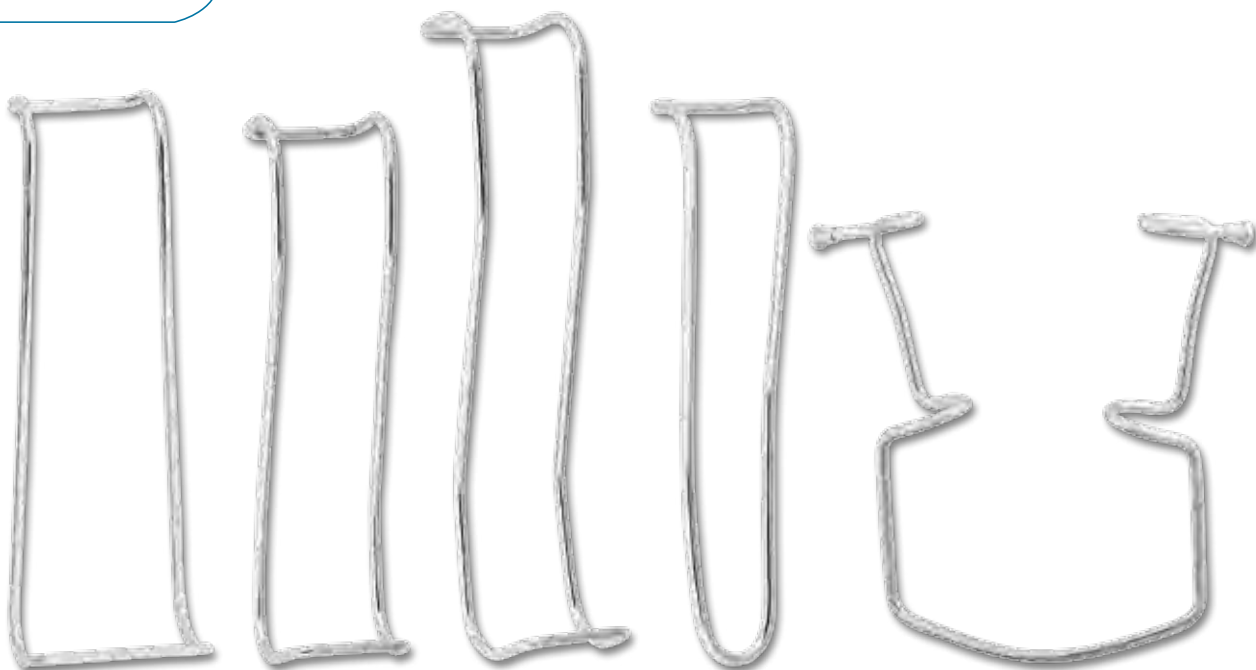

2601
Columbia
cm. 14,5

2602-1
Sternberg
cm. 14

2602-2
Sternberg
cm. 16

2602-3
Sternberg
cm. 14

2609-2
Oringer medium
cm. 11 x 8

■ Abbassalingua

Tongue depressor



2605
cm. 14,5

2606
cm. 14,5

2607
Buchwald
cm. 17

2608
Brünings
cm. 19

■ Divaricatore per guance

Cheek Retractor



2604
University of Minnesota
cm. 14

Dove nasce un sorriso...
Where smile rises...



Divaricatori

Retractors

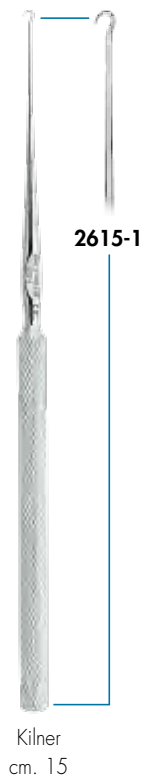
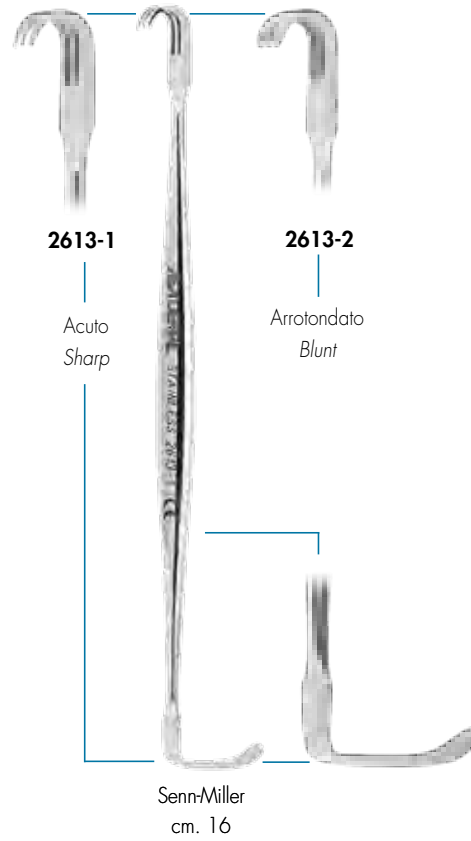

Dove nasce un sorriso...
Where smile rises...



Divaricatori

Retractors

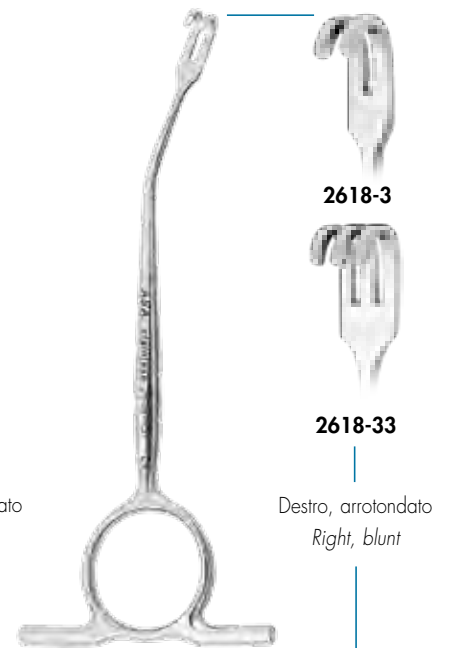
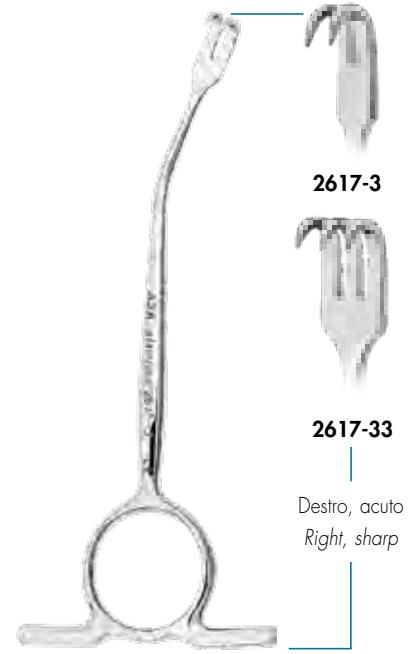

Dove nasce un sorriso...
Where smile rises...



Divaricatori

Retractors



2623-2
mm. 55x11

2623-1
mm. 40x11
Kocher
cm. 21



2624-2
mm. 55x11

2624-1
mm. 40x11
Kocher
cm. 21



2625-1
mm. 72x11
cm. 21



2626-1
mm. 35x11
cm. 21

Divaricatori per
spina nasalis

Ramus retractors
for nasal spine



Langenbeck
cm. 21



2621-1
mm. 30x11



2621-2
mm. 30x14

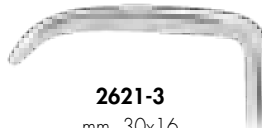

2621-3
mm. 30x16

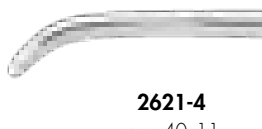

2621-4
mm. 40x11



2621-5
mm. 50x11



Langenbeck
cm. 21



2622-1
mm. 30x11



2622-2
mm. 30x14



2622-3
mm. 30x16

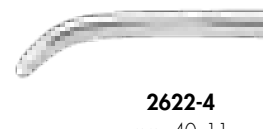

2622-4
mm. 40x11



2622-5
mm. 50x11

Dove nasce un sorriso...
Where smile rises...



Divaricatori

Retractors



Middeldorpf

mm. 14x17

2620-1
cm. 21,5



mm. 20x22

2620-2
cm. 22



mm. 26x30

2620-3
cm. 23,5



2627
cm. 20

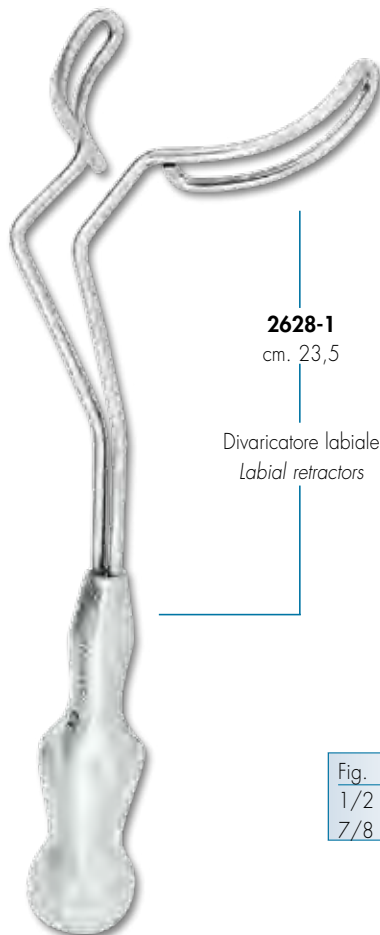

2628-1
cm. 23,5

Divaricatore labiale
Labial retractors

■ Sonde Seno Mascellare Antrum Probes



2650-02
Bowman
cm. 12,5



2650-08
Bowman
cm. 13,5

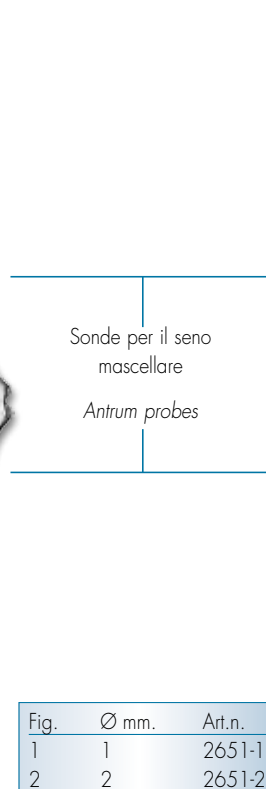

Sonde per il seno
mascellare
Antrum probes



2651-1
cm. 14



2651-2
cm. 14

Fig.	Ø mm.	Art.n.
1/2	0,9/1,1	2650-02
7/8	1,8/1,9	2650-08

Fig.	Ø mm.	Art.n.
1	1	2651-1
2	2	2651-2

Dove nasce un sorriso...
Where smile rises...



Pinzette Chirurgiche

Tissue Pliers

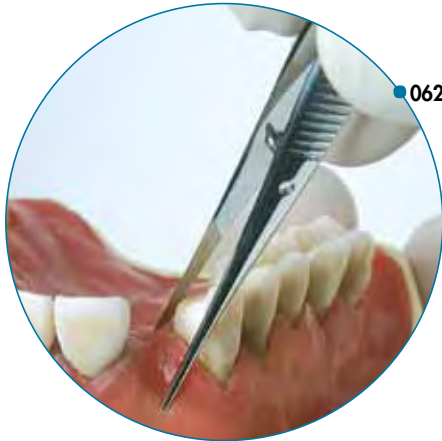

0620-1 Pinzetta chirurgica Adson con punte sottile
Adson tissue pliers with fine tips



0623-1 Pinzetta chirurgica dritta con punte molto fini
Tissue pliers with very fine tips, straight



0620-1
Fig. 1
Adson
cm. 12

0621-1
Fig. 1
Adson 1x2
cm. 12

0622-1
Fig. 1
Micro-Adson 1x2
cm. 12

0622-2
Fig. 2
Micro-Adson 1x2
cm. 15

0623-1
Molto fine
Very fine
cm. 10

0624-1
Micro-Adson
cm. 12

0624-2
Micro-Adson
cm. 15

Dove nasce un sorriso...
Where smile rises...



Pinzette Chirurgiche - Pinzette per Sutura

Tissue Pliers - Suture Pliers

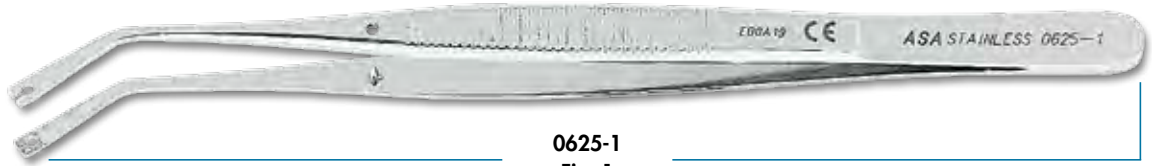

0625-1

Fig. 1

cm. 15

Pinzette per sutura

Suture pliers

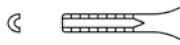

0626-1

Adson Brown
non traumatic
cm. 12



0630-1

Fig. 1
Semken-Taylor
cm. 12,5



0630-2

Fig. 2
Semken-Taylor
cm. 12,5



0631-1

Fig. 1
Semken-Taylor 1x2
cm. 12,5

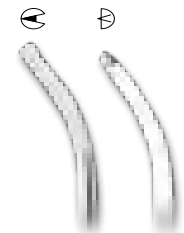

0631-2

Fig. 2
Semken-Taylor 1x2
cm. 12,5

Dove nasce un sorriso...
Where smile rises...

ASA DENTAL®

Pinzette Chirurgiche

Tissue Pliers



S0645
Serie da 5 pezzi
Set of 5



● **0645-1** Pinzetta chirurgica per lembi con punte estremamente sottile
Tissue pliers with very fine tips

Punte molto sottili
Very fine tips



0645-1
Fig. 1
cm. 12,5



0645-2
Fig. 2
cm. 12



0645-3
Fig. 3
cm. 11,5



0645-4
Fig. 4
cm. 11,5



0645-5
Fig. 5
cm. 11,5

Pinzette Chirurgiche

Dove nasce un sorriso...
Where smile rises...



Tissue Pliers



0635-1
Fig. 1
cm. 13



0635-2
Fig. 2
cm. 14



0635-3
Fig. 3
cm. 15



0635-4
Fig. 4
cm. 18



0635-5
Fig. 5
cm. 20,5

*Dove nasce un sorriso...
Where smile rises...*



Cannule Aspirasaliva Chirurgiche

Surgical Saliva Ejectors

■ Cannule Aspirasaliva in Acciaio

Stainless Steel Saliva Ejectors

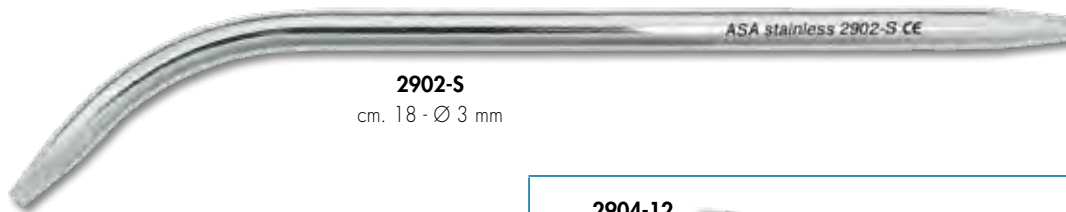

2902-S
cm. 18 - Ø 3 mm



2902-M
cm. 18 - Ø 4 mm



2902-L
cm. 18 - Ø 5 mm

2904-12
Fig. 12FR

Frazier
cm. 15 - Ø 4 mm



2904-10
Fig. 10FR

Frazier
cm. 15 - Ø 3,3 mm



2904-8
Fig. 8FR

Frazier
cm. 15 - Ø 2,7 mm



2904-6
Fig. 6FR
Frazier
cm. 15 - Ø 2 mm

■ Cannule Aspirasaliva

Aspirator Tips



2905-AD



2905-155

Cannula sagomata universale per aspiratore chirurgico, sterilizzabile in autoclave.

Aspirator tips specially shaped for surgical use, autoclavable.

Adattatore sterilizzabile in autoclave per cannula 2905-155.
Autoclavable adaptor for 2905-155.

Implant Surgery

Compattatori
Compactors



MV1230-1 Fig. 1
MV1230-2 Fig. 2



0491-1
cm. 17,5
Spessimetro per osso
Bone thickness gauge

Iniettore
per osso
Bone
injector

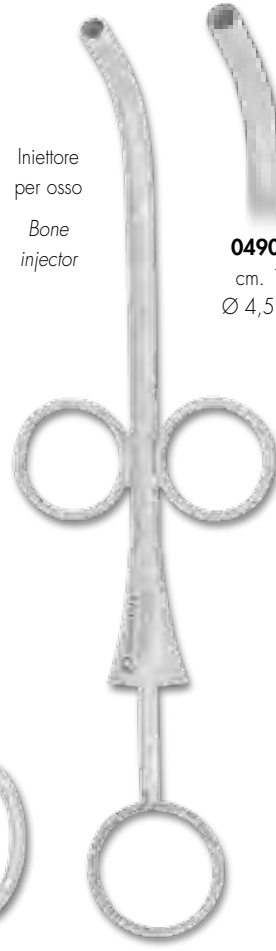

0490-2
cm. 16
Ø 4,5 mm

0490-1
cm. 16
Ø 2,5 mm

Cucchiaio
per osso
Bone
curette



2014-3
Fig. 3



Mortaiο per osso
Bone well

1030-1
Ø cm. 3,5
h. cm. 3,5

Dove nasce un sorriso...
Where smile rises...



Chirurgia Implantare

Implant Surgery



Martelli chirurgici
Surgical mallets

Con piombo
Lead filling

1880
Partsch
cm. 19

1881
Mead
cm. 19,5



1881-R
Coppia inserti di ricambio
in plastica autoclavabile
max 140°

N° 2 plastic inserts
autoclavable max 140°

Scalpelli Freer taglio singolo
Freer single cut scalpels

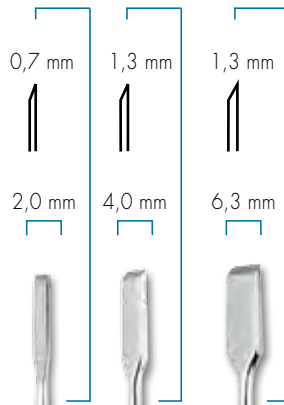

1839-1 Fig. 1 Freer
1839-2 Fig. 2 Freer
1839-3 Fig. 3 Freer

Scalpelli graduati
Graduated scalpels



1840-1 Fig. 1 mm 3,8 Retto
Straight
1840-2 Fig. 2 mm 3,8 Curvo
Curved
1840-3 Fig. 3 mm 7,5 Retto
Straight
1840-4 Fig. 4 mm 7,5 Curvo
Curved

Chirurgia Implantare

Dove nasce un sorriso...
Where smile rises...



Implant Surgery

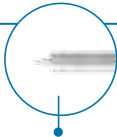

Posizionatore di membrane
Membrane placement instrument

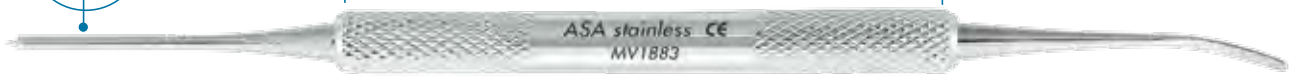

MV1883
Buser

MV1850-M8
Scollaperiosto Molt-M8- universale
Molt universal periosteal elevator M8



MV1850-M7
Fig. M7
Molt

MV1850-M8
Fig. M8
Molt

MV1850-M9
Fig. M9
Molt

MV1851-2
Fig. 2
Hourigan

MV1851-PR3
Fig. PR3
Prichard

MV1850-9A
Fig. 9A
Allen

MV1850-GF
Fig. GF
Goldman-Fox

1857-1
Williger
cm. 16

Dove nasce un sorriso...
Where smile rises...



Chirurgia Implantare

Implant Surgery

■ Osteotomi Osteotomes

S0495-6

Serie da 6 pezzi
Set of 6

Contenuto/Contents: 0495-1, 0495-2,
0495-3, 0495-4, 0495-5, 0495-6, S2702

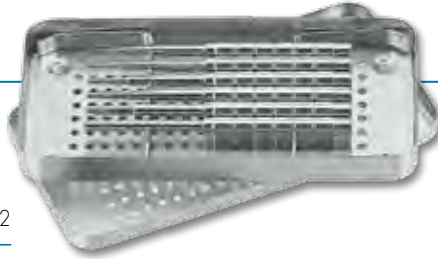

Estremità concava
Concave end

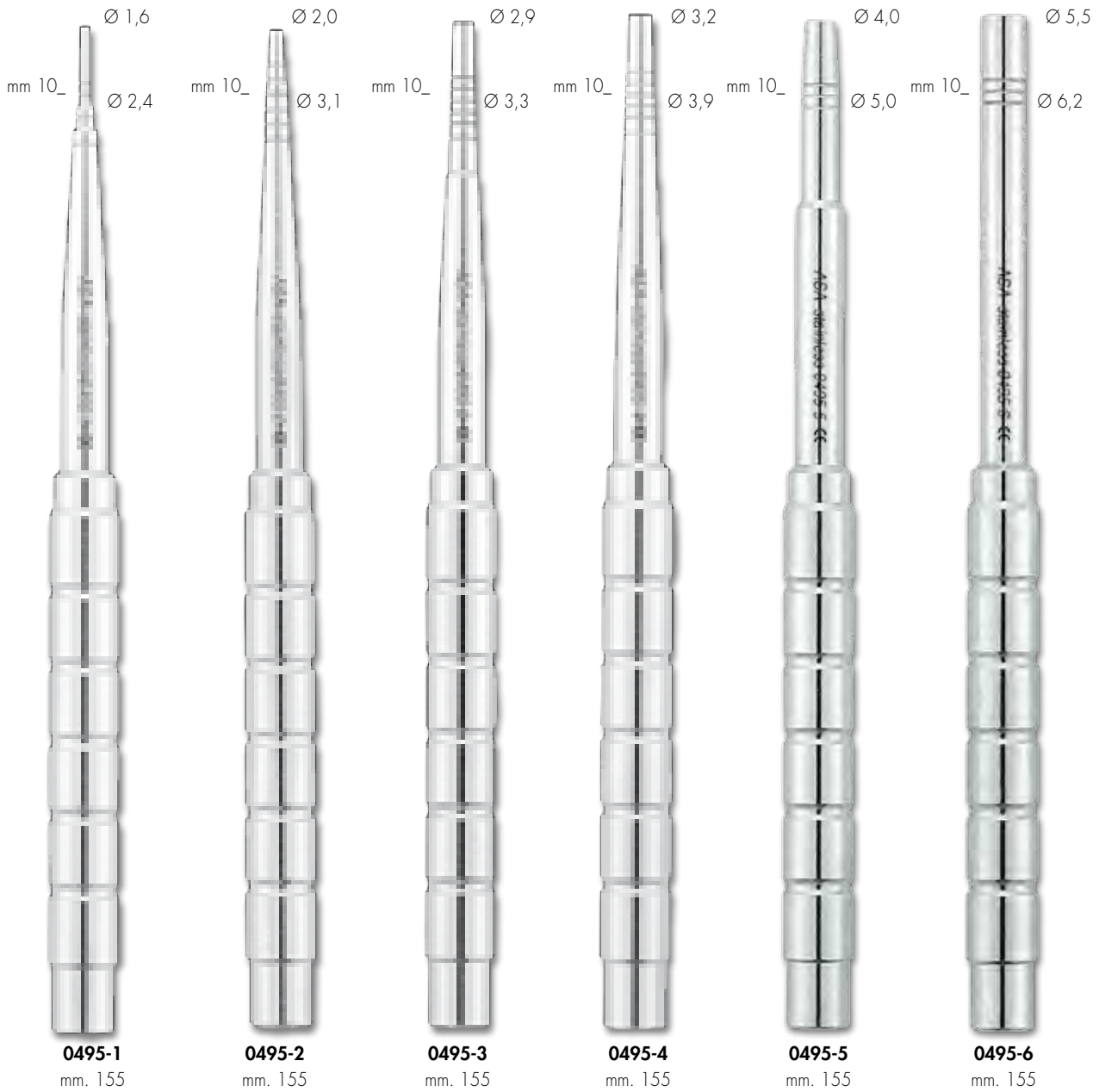
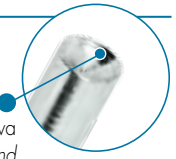

0495-1
mm. 155

0495-2
mm. 155

0495-3
mm. 155

0495-4
mm. 155

0495-5
mm. 155

0495-6
mm. 155

■ Periotomi Periotomes

ML1845-1 — Fig. 1



ML1845-2 — Fig. 2



ML1845-3 — Fig. 3



Dove nasce un sorriso...
Where smile rises...



Chirurgia Implantare

Implant Surgery

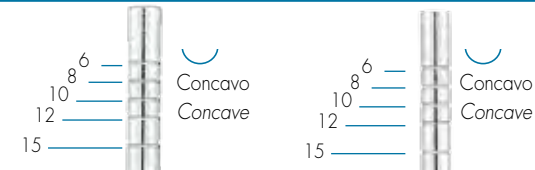

S0498-8

Set mini rialzo del seno
Mini sinus lift kit

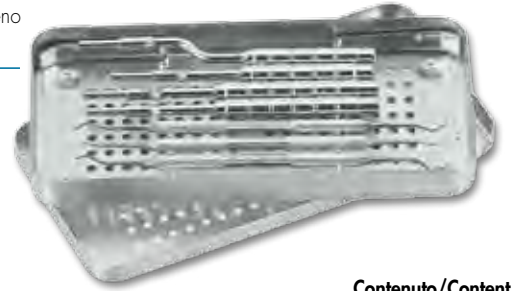

Contenuto/Contents:

0498-1B4, 0498-2C4, 0498-30B4, 0498-PF4,
1902-2, 1809-1, 1831-32, 2001-87, S2702

Mini rialzo del seno
Mini sinus lift



0498-1B4
Ø mm. 4

0498-1B5
Ø mm. 5

0498-1B3
mm. 165
Ø mm. 3



0498-2C4
Ø mm. 4

0498-2C5
Ø mm. 5

0498-2C3
mm. 165
Ø mm. 3

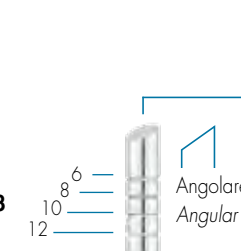

0498-30B4
Ø mm. 4

0498-30B5
Ø mm. 5

0498-30B3
mm. 165
Ø mm. 3

Osteotomi anulari con stop
Annular osteotomes with setting point

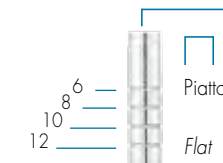

0498-PF4
Ø mm. 4

0498-PF5
Ø mm. 5

0498-PF3
mm. 120
Ø mm. 3

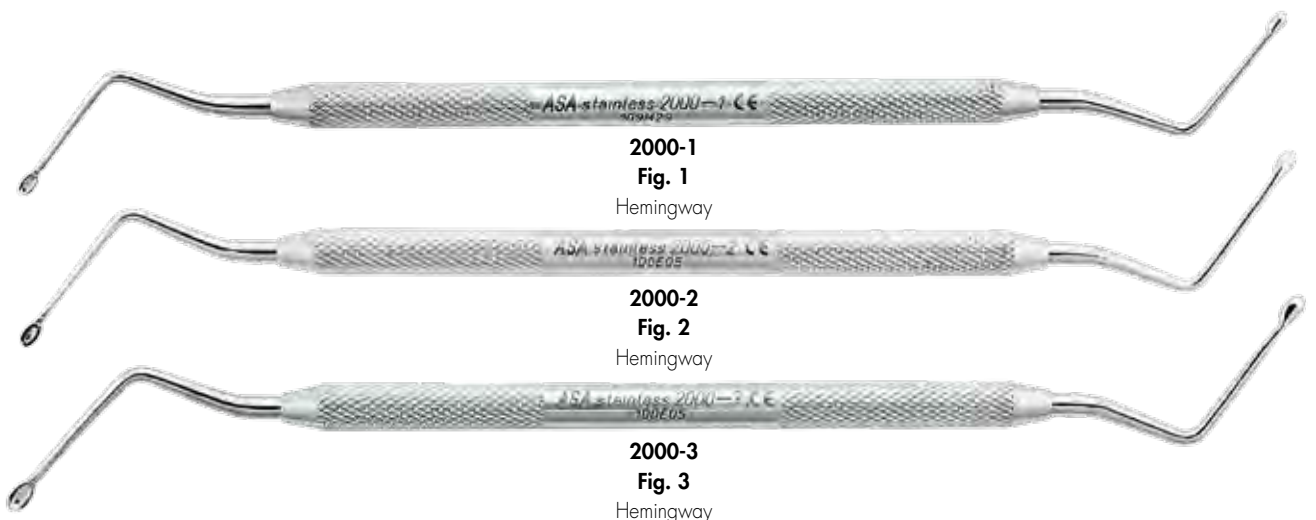

Dove nasce un sorriso...
Where smile rises...



Chirurgia Implantare

Implant Surgery

Dilatatori ed espansori Implant site dilators

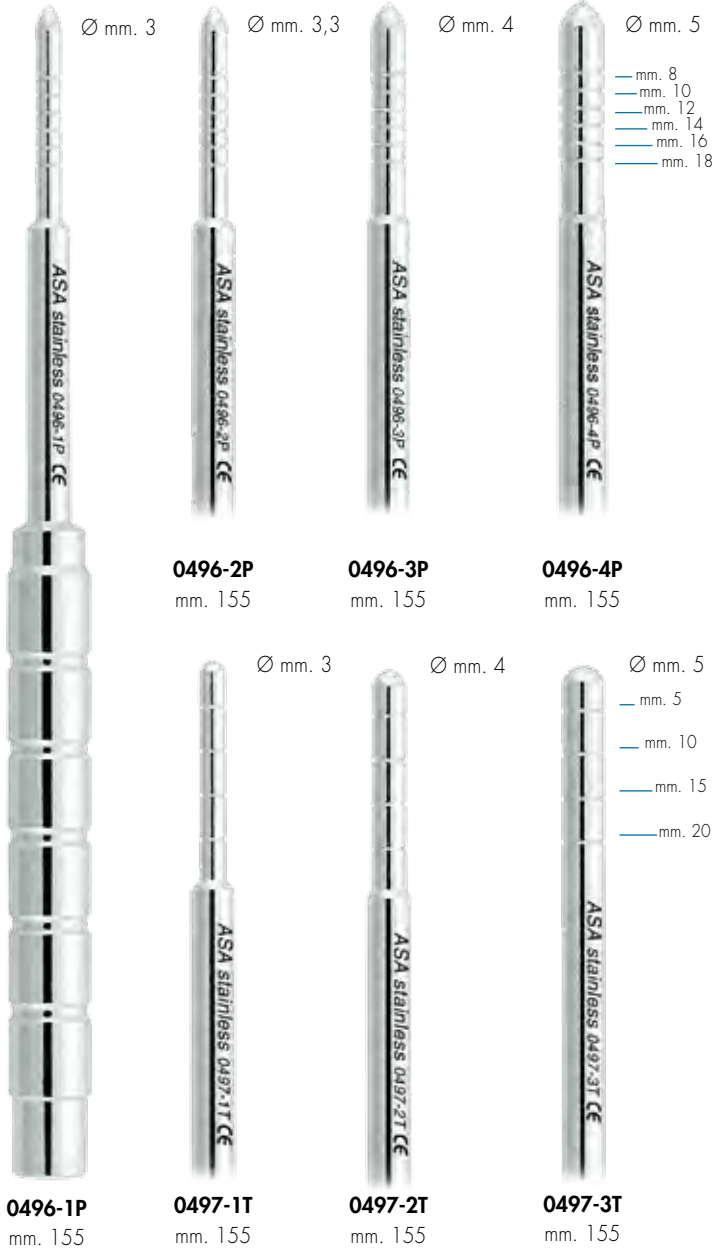

Frese carotatrici Trepine punte millimetrata Trepine burs

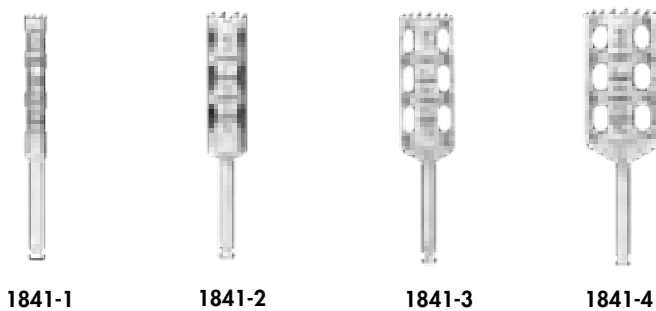

Curettes per sinus lift Sinus lift curettes



Implant Surgery

■ Curettes per sinus lift Sinus lift curettes

MV1856-5
Curette per sinus lift n. 5
Sinus lift curette n.5

MV1856-8
Curette con angolo a 90°
per sinus lift n. 8
Sinus lift curette n.8
90° angled

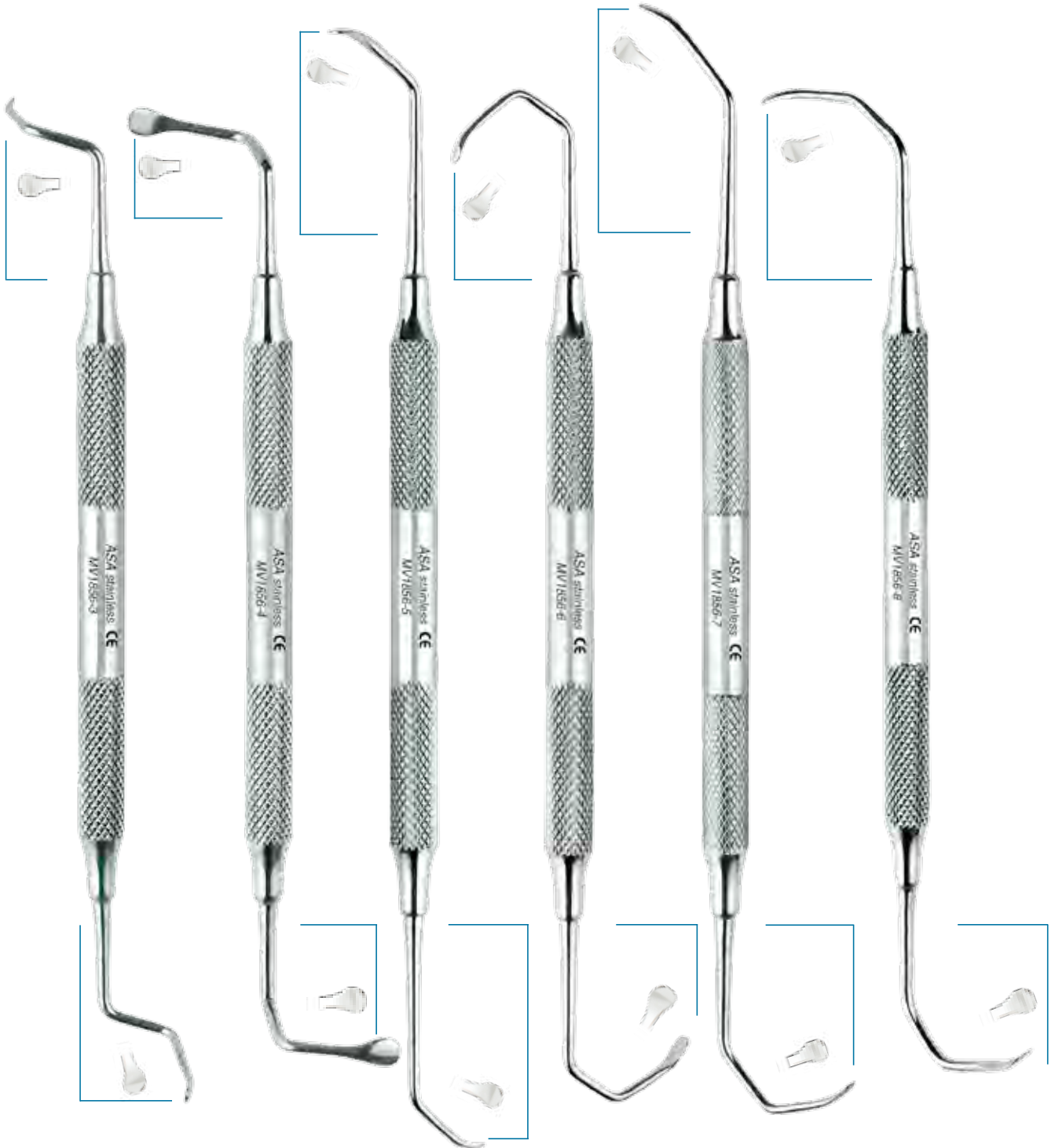

MV1856-3
Fig. 3

MV1856-4
Fig. 4

MV1856-5
Fig. 5

MV1856-6
Fig. 6

MV1856-7
Fig. 7

MV1856-8
Fig. 8

Dove nasce un sorriso...
Where smile rises...



Chirurgia Implantare

Implant Surgery

■ Scollatori endostali Periosteal elevators



MV1855-1
Fig. 1



MV1855-2
Fig. 2



MV1855-3
Fig. 3



MV1855-4
Fig. 4



MV1855-5
Fig. 5



MV1855-6
Fig. 6

Implant Surgery

■ **Forbicine chirurgiche**
Surgical scissors



0304-1
Fig. 1
Goldman-Fox
cm. 13

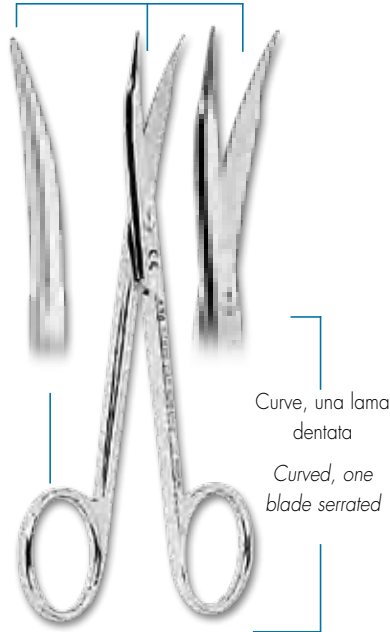

0304-2
Fig. 2
Goldman-Fox
cm. 13

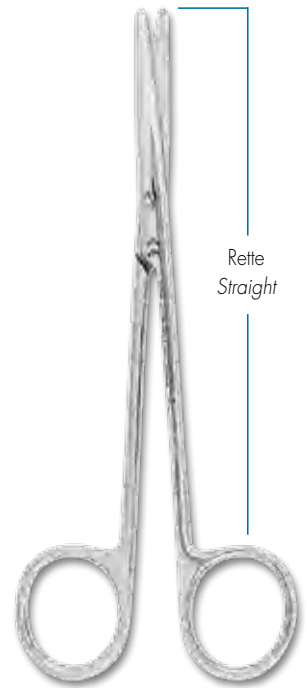

0322-1
Fig. 1
Metzenbaum-Delikat
cm. 14,5



0309-1TC
Fig. 1TC
Kelly
cm. 16



0309-2TC
Fig. 2TC
Kelly
cm. 16

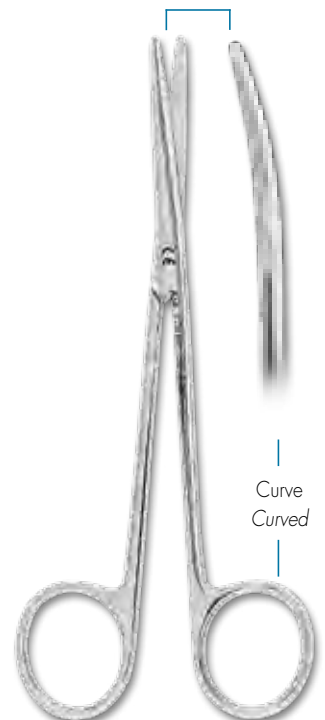

0322-2
Fig. 2
Metzenbaum-Delikat
cm. 14,5

Dove nasce un sorriso...
Where smile rises...



Chirurgia Implantare

Implant Surgery

■ Porta aghi con inserti al carburo di tungsteno
Needle holders with tungsten carbide inserts



0435-14TC
Mathieu TC
cm. 14



0435-17TC
Mathieu TC
cm. 17



0437-17TC
Lichtenberg
cm. 17



0450-18TC
Micro-Barraquer TC
cm. 18



0445-14TC
Castroviejo TC
cm. 14



0446-14TC
Castroviejo TC
cm. 14



0448-14TC
Castroviejo TC
cm. 14/60°

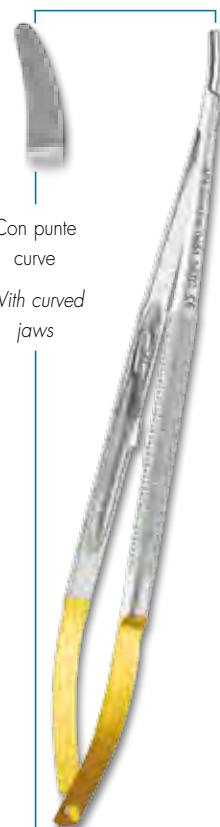

Con punte curve
With curved jaws

0451-18TC
Micro-Barraquer TC
cm. 18

Chirurgia Implantare

Dove nasce un sorriso...
Where smile rises...



Implant Surgery



1/1

0493-2
Filtro di ricambio a maglia media

Spare filter medium grid

Ø 5 mm
27 mm

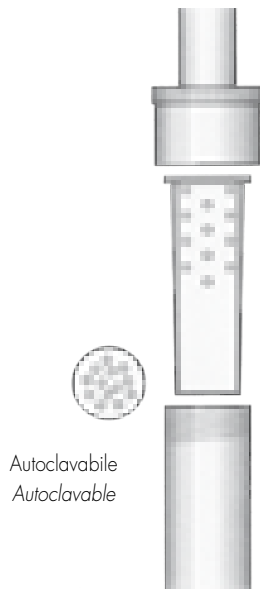

Autoclavabile
Autoclavable

0493-1
200 mm

Cannula Aspirasaliva, filtro recupero osso
Surgical Saliva Ejector, bone filter

Raschietto per osso
Bone scraper

Lama
Blade



0494-1
cm. 15
Retto/Straight



0494-1R
Lama per 0494-1
Retto
Blade for 0494-1
Straight



0494-2
cm. 15
Curvo/Curved

0494-2R
Lama per 0494-2
Curvo
Blade for 0494-2
Curved

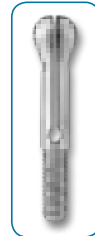

Manico per micro lame
Handle for Micro-Blades



0365-1
cm. 13,5



0366-4
Fig. 4



0366-7
Fig. 7

Dove nasce un sorriso...
Where smile rises...



Chirurgia Implantare

Implant Surgery

■ Divaricatori per impianti Implant retractors

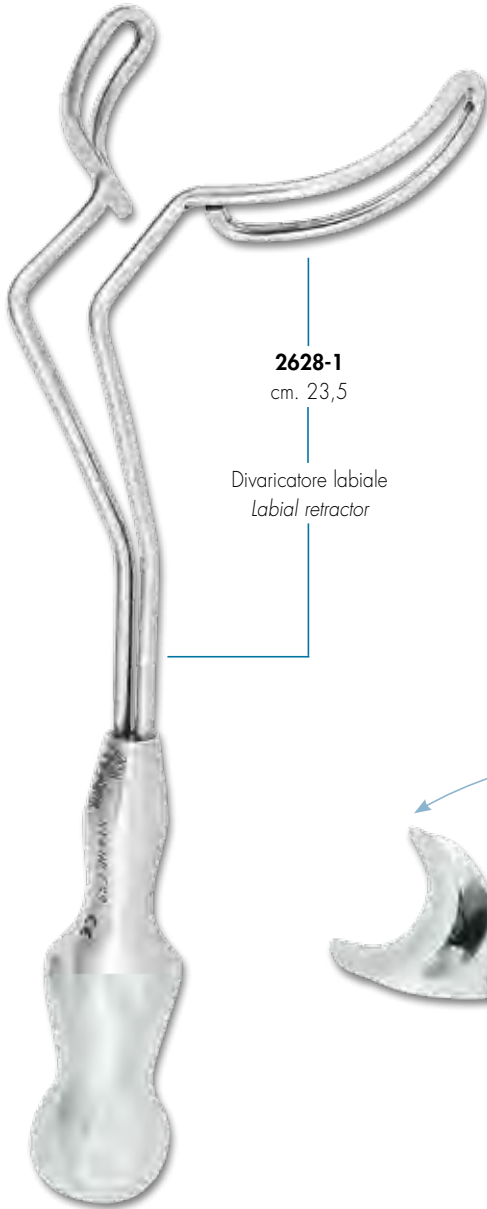

2628-1
cm. 23,5

Divaricatore labiale
Labial retractor



2602-1
Sternberg
cm. 14

Divaricatore per
guance
Cheek retractor



2604
University of Minnesota
cm. 14



2627
cm. 20



2620-1
Middeldorpf
cm. 21,5

**LASER
SYSTEM**

Sonde millimetriche
Pocket probes



0702L-11
CP-11

0702L-12
CP-12

0702L-12S
CP-12S
O.M.S.

Pinzette chirurgiche
Tissue pliers



0620-1
Fig. 1
Adson
cm. 12

0621-1
Fig. 1
Adson 1x2
cm. 12

0630-1
Fig. 1
Semken-Taylor
cm. 12,5

0630-2
Fig. 2
Semken-Taylor
cm. 12,5

Dove nasce un sorriso...
Where smile rises...



Chirurgia Implantare

Implant Surgery

Pinze ossivore Alveolotome

Bone Rongeurs

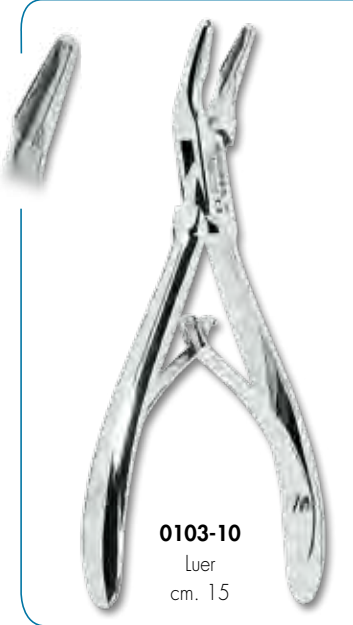

0103-10
Luer
cm. 15



0103-30
Blumenthal
cm. 15



0103-31
Blumenthal 45°
cm. 14,5

Pinzette per marcare le tasche

Periodontal pocket markers



0650-1
Fig. 1
Goldman-Fox
cm. 15

0650-2
Fig. 2
Goldman-Fox
cm. 15



0103-25
Mini Friedman
cm. 12

Pinza per tessuti

Bone/soft tissue nipper



0103-60
Goldman-Fox
cm. 10

Set di Strumenti per Implantologia

Implantology Instruments kit



S3001-20

Kit Goracci
Goracci kit

Contenuto/contents:

0300-1	Forbicine gengive rette Gum scissors straight	1600-1	Cleoidi discoidi inox Fig. 1 Cleodis Discoids Fig. 1
0601-1	Pinzette medicazione Flagg Flagg Cotton & dressing pliers	1601-1	Strumento da smalto Black Fig. 26 Black Fig. 26 margin trimmer
0704-23D2	Sonda doppia Fig. 23 e 17A Explorer d. e. Fig. 23 - 17A	1601-2	Strumento da smalto Black Fig. 27 Black Fig. 27 margin trimmer
0903-2	Spatola doppia per cemento Cement spatulas double ended	1700-1	Escavatore doppio Fig. 1 Double ended excavator Fig. 1
1101-2	Spatola Heidemann inox Heidemann separating spatulas	1700-2	Escavatore doppio Fig. 2 Double ended excavator Fig. 2
1200-2	Otturatore doppio Fig. 2 Filling instrument Fig. 2	1700-3	Escavatore doppio Fig. 3 Double ended excavator Fig. 3
1202-1L	Otturatore doppio Fig. 1L Filling instrument Fig. 1L	1700-4	Escavatore doppio Fig. 4 Double ended excavator Fig. 4
1202-2L	Otturatore doppio Fig. 2L Filling instrument Fig. 2L	2102-IN	Manico per specchio Mirror handle
1211-1T	Otturatori Tanner Fig. 1 Tanner Fig. 1T filling instrument	2200-5	Specchietto piano n°5 (1) Mouth mirror plane n°5 (1)
1301	Applicatore Inox Placement Instrument	S2721-2	Vassoio Instruments tray
1500-02	Strumento Hollenback 1/2 Hollenback amalgam covers 1/2		

Contenuto/contents:

MV1850-M9	Scollaperiosteo Molt Molt periosteal
MV1851-PR3	Scollaperiosteo Prichard Prichard periosteal
MV1850-GF	Scollaperiosteo Goldman-Fox Goldman-Fox periosteal
MV1803-D	Bisturi Kirkland Kirkland knife
1881	Martello Mead Mead mallet
0446-14TC	Porta aghi Castroviejo Castroviejo needle holder
0435-17TC	Porta aghi Mathieu Mathieu needle holder
0350-3	Manico per bisturi Scalpel handle
S2722-1	Vassoio Instrument Tray



S3003-9

Contenuto/Contents:

0350-3	Manico per bisturi Scalpel handle
2602-1	Retratore Sternberg Sternberg retractor
0304-2	Forbice Goldman-Fox Goldman-Fox scissor
MV1850-M9	Scollaperiosteo Molt Molt periosteal
MV1851-PR3	Scollaperiosteo Prichard Prichard periosteal
0415-15TC	Porta aghi Crile Wood Crile Wood needle holder
0631-1	Pinzetta chirurgica Semken Taylor Semken Taylor tissue plier
0700-23	Sonda Explorer
2102-IN	Manico per specchio Mouth mirror handle
2200-5	Specchietto (1) Mouth mirror (1)
S2722-1	Vassoio Instrument Tray
0351-11	Lame monouso (100 pezzi) Disposable blades (100 pcs)



S3003-11